

GENERAL

Fluid	Air or neutral gaz, filtered, lubricated or not
Operating pressure	1,5 to 8 bar
Ambient temperature	+5°C to +50°C
Orifice size	519 : 2,5 mm; 520 : 4 mm; 521 : 6 mm
Flow (Qv at 6 bar)	series 519 175 l/min (ANR) - Kv : 2,5 series 520 600 l/min (ANR) - Kv : 8,5 series 521 1050 l/min (ANR) - Kv : 15

CONSTRUCTION

SPOOL VALVES

Body	Anodised white aluminium
Cover	POM (polyacetal)
Internal parts	Stainless steel, light alloy and POM (polyacetal)
Seals	NBR (nitrile)
Manual operator	Maintained, impulse Latchable in hold position (push-turn)

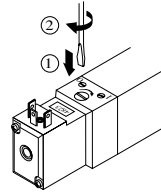

PILOT

Seals	NBR (nitrile)
Electrical equipment	Conforming to NF C79300 standard
Coil and iron circuit	Encapsulated

ELECTRICAL CHARACTERISTICS

voltages		consumption	insulation class	protection degree	electrical connection
~	24V, 115V, 230V - 50/60Hz	2 VA (1,5 W)	F	IP 65	spade plug size 15 connector, DIN 43650, 9,4 mm, industry standard B, rotatable by 90°
=	24V	1,6 W			

SPECIFICATIONS

function symbol	operators solenoid air operated pilot (14) return (12)	response time (ms)		voltages	catalogue number		
		energized	de-energized		serie 519	serie 520	serie 521
	spring return	20	30	24V ~ 115V ~ 230V ~ 24V =	- - - 52000380	52000386 52000387 52000388	- - -
	differential return	20	30	24V ~ 115V ~ 230V ~ 24V =	51900002 51900003 51900004 51900001	52000002 52000003 52000004 52000001	52100002 52100003 52100004 52100001
	solenoid air return	20	-	24V ~ 115V ~ 230V ~ 24V =	51900006 51900007 51900008 51900005	52000006 52000007 52000008 52000005	52100006 52100007 52100008 52100005
	pressure held W1	20	50	24V ~ 115V ~ 230V ~ 24V =	51900010 51900011 51900012 51900009	52000010 52000011 52000012 52000009	52100010 52100011 52100012 52100009
	pressure applied W2	20	50	24V ~ 115V ~ 230V ~ 24V =	51900126 51900127 51900128 51900129	52000126 52000127 52000128 52000129	52100126 52100127 52100128 52100129
	pressure release W3	20	50	24V ~ 115V ~ 230V ~ 24V =	51900087 51900088 51900089 51900090	52000087 52000088 52000089 52000090	52100087 52100088 52100089 52100090

OPTIONS AND ACCESSORIES

UR approval « UL Recognized »	24V =/~	612102
visual indicator (LED) and electrical protection ()	24V =/~ 115V ~ 230V ~	88130401 88130402 88130403
connector size 15 with cable, 2 m long		88143567
connector size 15 with built-in visual indication and protection, with cable outlet, 2 m long ()	24V =/~	88143580
flange for ports 2 - 4 with instant fittings for flexible tube 6 mm O.D. (series 520)		88135532

SUBBASES : possible mounting on joinable subbases (). Fixing screws and seals are supplied with subbases

All leaflets are available on: www.ascocom

DIMENSIONS (mm), WEIGHT (kg)

5/2 differential return and spring return

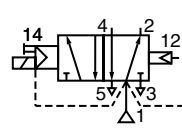
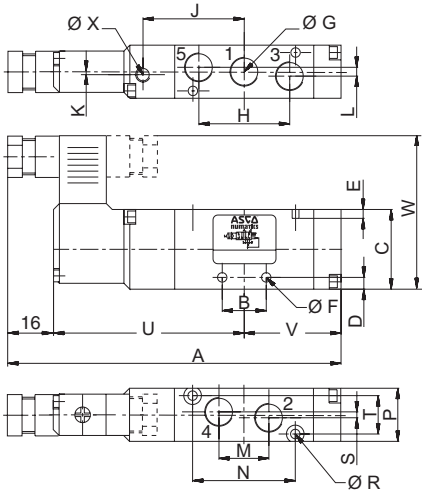

series	A	V
519	97,5	25
520	114	33,2
521	131,3	41,6

weight	
519	0,085
520	0,095
521	0,155

series	B	C	D	E	ØF	ØG	H	J	K	L	M	N	P	ØR	S	T	U	W	ØX	
5/2	519	11	26	4	4	3,3	M5	21,6	26	-	-	11	19	15	2,7	6	11	56,5	52	4
	520	15	27	6	3	3,3	G1/8	32,4	34,3	1	3	16,2	35	18	3,2	-	13	64,8	54,5	4
	521	22	31	6,5	4	4,3	G1/4	44	43,2	-	4	22	50	22	4,2	4	16	73,7	56,5	3

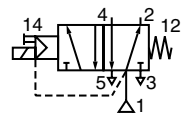

series	A	V
519	97,5	-
520	123,3	42,5
521	131,3	-

5/2 solenoid air return

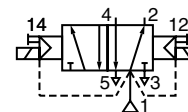
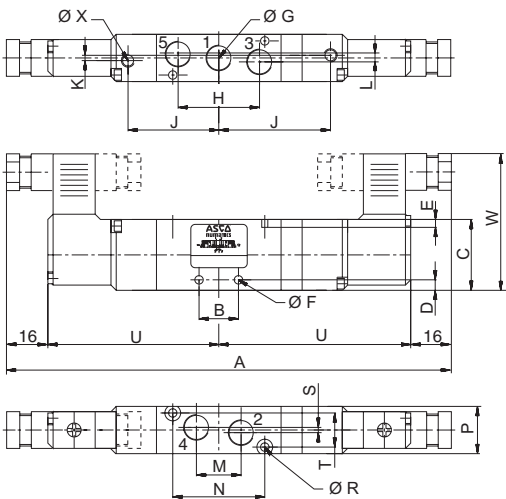

weight	
519	0,135
520	0,160
521	0,200

series	A	B	C	D	E	ØF	ØG	H	J	K	L	M	N	P	ØR	S	T	U	W	ØX	
5/2	519	145	11	26	4	4	3,3	M5	21,6	26	-	-	11	19	15	2,7	6	11	56,5	52	4
	520	161,5	15	27	6	3	3,3	G1/8	32,4	34,3	2	3	16,2	35	18	3,2	-	13	64,8	54,5	4
	521	179,5	22	31	6,5	4	4,3	G1/4	44	43,2	-	4	22	50	22	4,2	4	16	73,7	56,5	3

5/3 solenoid air return

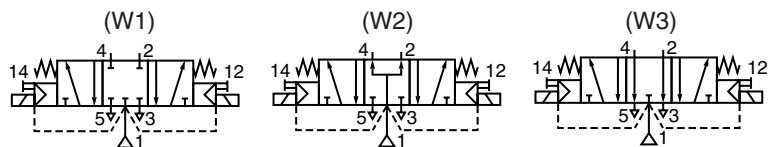
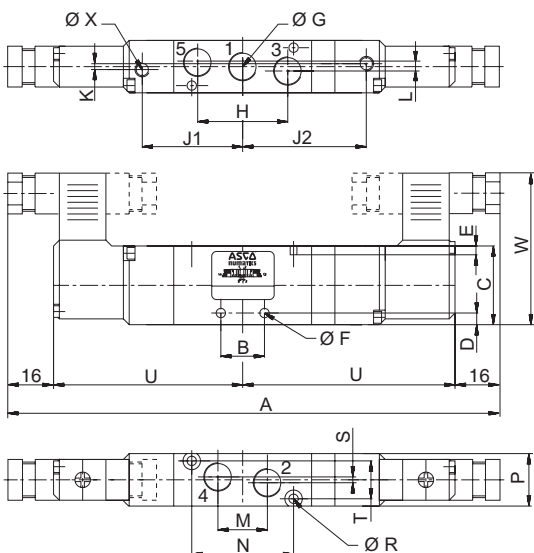

series	A	B	C	D	E	ØF	ØG	H	J1	J2	K	L	M	N	P	ØR	
5/3	519	153	11	26	4	4	3,3	M5	21,6	26	34	-	-	11	19	15	2,7
	520	170,3	15	27	6	3	3,3	G1/8	32,4	34,3	43,3	1	3	16,2	35	18	3,2
	521	188,3	22	31	6,5	4	4,3	G1/4	44	43,2	52,1	-	4	22	50	22	4,2

series	S	T	U	V	W	ØX	weight	
5/3	519	6	11	56,5	64,5	52	4	0,140
	520	-	13	64,8	73,7	54,5	4	0,170
	521	4	16	73,7	82,6	56,5	3	0,210

00439GB-2017/R01
Availability, design and specifications are subject to change without notice. All rights reserved.