

Operating Manual for Bettis RTS FL Series

Fail-Safe Linear Electric Actuator



Table of Contents

Section 1: Introduction

Section 2: Functional Description of the RTS FL Fail-Safe Linear Actuator

2.1	Fail-Safe Direction	3
2.2	Option Manual Override.....	3

Section 3: General Information

3.1	Safety Instructions	5
3.2	Serial Number and Type Label	5
3.3	Operating Mode.....	6
3.4	Protection Class	6
3.5	Mounting Position	7
3.6	Direction of Rotation.....	7
3.7	Protection Devices	8
3.8	Ambient Temperature.....	8
3.9	Delivery Condition of the Actuators	8
3.10	Information Notice (Tag)	9

Section 4: Packaging, Transport and Storage

4.1	General	10
4.2	Storage	10
4.3	Long-term Storage.....	11

Section 5: Installation Instructions

5.1	Mechanical Connection.....	12
5.2	Mounting of Linear Fail-Safe Actuator.....	13
5.3	Mounting Position of the Operating Unit.....	16
5.4	Electrical Connection	17

Section 6: Commissioning

6.1	General Information	20
6.2	Manual Operation	20
6.3	Mechanical Default Settings and Preparation	21
6.4	End Limit Setting.....	22
6.5	Adjusting of Fail-Safe Speed	28
6.6	Final Step	30

Section 7: Control Unit

7.1	Operating Unit	31
7.2	Display Elements	32
7.3	Operation	34

Section 8: Parameter Menu

8.1	Parameter Group: End Limit	43
8.2	Parameter Group: Torque	45
8.3	Parameter Group: Speed	46
8.4	Parameter Group: Ramp (optional)	46
8.5	Parameter Group: Control	47
8.6	Parameter Group: Password	47
8.7	Parameter Group: Position	48
8.8	Parameter Group: Binary Inputs	49
8.9	Parameter Group: Binary Outputs	52
8.10	Parameter Group: Position Output (optional)	56
8.11	Parameter Group: Step Mode	57
8.12	Parameter Group: Positioner (option).....	59
8.13	Parameter Group: PID Controller (optional).....	61
8.14	Parameter Group: Characteristic Curves (optional).....	63
8.15	Parameter Group: Identification (option).....	64
8.16	Parameter Group: System Parameters (locked)	64
8.17	Parameter Group: Miscellaneous	65

Section 9: Status Area

9.1	Status	66
9.2	History.....	69

Section 10: Infrared Connection

Section 11: Bluetooth Link

Section 12: Maintenance

Section 13: Troubleshooting

13.1	Error List	73
------	------------------	----

Section 14: Fuses

Section 15: Lubricant Recommendations and Requirements

15.1 Main Body: -25°C to +60°C	76
15.2 Main Body: -40°C to +60°C	76
15.3 Output type A and spindle drives (Linear Actuators) -40 to +60C.....	76
15.4 Basic Lubricant Service Interval	76

Section 16: Training

Section 17: Technical Data and Certifications

17.1 Binary Outputs.....	79
17.2 Binary Inputs.....	80
17.3 Analog Inputs.....	84
17.4 Analog Output	84
17.5 Auxiliary Voltage Input and Output	86
17.6 Connections	87
17.7 Miscellaneous	87

Section 1: Introduction

Bettis RTS FL Fail-Safe electric actuators are designed to operate appropriate valves when a fail-safe functionality is required.

Appropriate valves are all kind of valves that require a linear movement to operate (globe valve, gate valves, etc.).

In the event of a power failure or if the fail-safe function is triggered deliberately, the linear Actusafe actuator shifts the valve to the fail-safe position, using the built-in energy storage device to do so.

Figure 1 Bettis RTS FL Fail-Safe Electric Actuator



Section 2: Functional Description of the RTS FL Fail-Safe Linear Actuator

In normal operation, the actuator is operated by a PM motor (1). Via a worm gear stage (2) and a planetary gear train (3), the motor drives the spindle nut of a ball screw (4). The sun gear shaft of the planetary gear train is fixed in place by an operating current brake (5).

The ball screw converts the rotational movement of the gear unit into linear motion, which, on the one hand, charges the spring packet (6), which acts as an energy storage device.

On the other hand, the linear motion is transmitted to the valve stem (8) via a spring-loaded spindle pin (7).

There are no engaging or disengaging elements between the motor, the energy storage device and the fitting shaft in the actuator. All the gear unit components are permanently engaged.

While moving against the fail-safe direction, the electric motor has to move both the valve and the energy storage device (disk spring assembly) for the fail-safe stroke.

If the supply for the operating current brake is interrupted (by a power failure, or intentionally to trigger a fail-safe stroke, the actuator will no longer be held, and the energy stored in the disk spring packet will be converted into kinetic energy so as to move the actuator and thus the valve to the fail-safe position. In this situation, the entire gear chain of the actuator with the exception of the worm gear stage will be moved until the end stop of the valve is reached. The spring-loaded spindle pin (7) dampens the stop and thus protects the valves seat.

Owing to this operating principle, neither an initialising stroke nor resetting of the drive is required after a fail-safe stroke. As soon as the power supply is restored, the actuator is immediately ready for operation.

Figure 2 Cutaway View of RTS FL Fail-Safe Linear Actuator

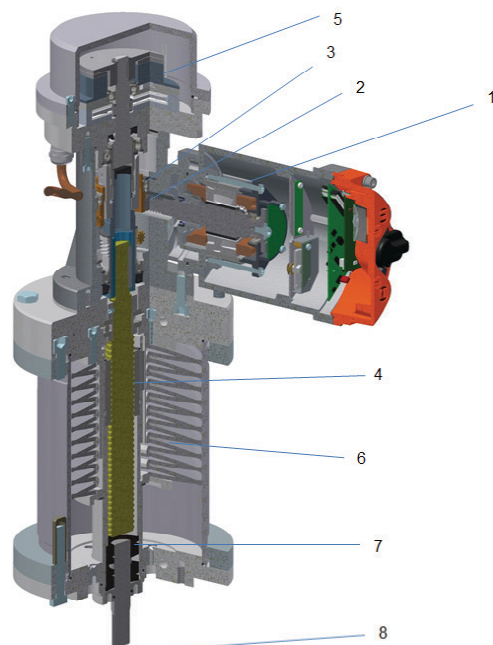

Parts Overview:

1. Motor
2. Worm Gear Stage
3. Planetary Gear Train
4. Ball Screw
5. Operating Current Brake
6. Spring Packet
7. Spring Loaded Spindle Pin
8. Valve Stem

2.1 Fail-Safe Direction

This type of fail-safe actuator can be built in two versions for "Fail-Safe Close" (extend actuator stem) or "Fail-Safe Open" (retract actuator stem).

2.2 Option Manual Override

RTS FL actuator can additionally be equipped with a manual mode. This additional option allows an adjustment of the valve in deenergized state.

CAUTION: MANUAL MODE OPERATION

- By activating the manual drive the fail-safe function is disabled.
- By activating the manual drive the electrical function of the drive is disabled.

In normal operation, the handwheel (9) is not engaged. By pushing the coupling rod (10), the handwheel is engaged and at the same time, disables the actuator electrically (switched to malfunction) and the fail-safe function. By using a padlock, the actuator can be protected against unintended manual operation or inadvertent activation of manual operation.

Figure 3 **RTS FL Fail-Safe Linear Actuator with Padlock**

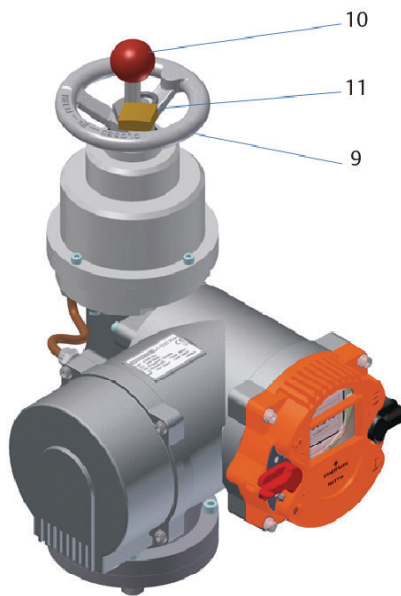

Parts Overview:

1. Handwheel
2. Coupling Rod
3. Padlock

Section 3: General Information

3.1 Safety Instructions

CAUTION: WORK UNDER GUIDANCE AND SUPERVISION

When operating electrical devices, certain parts are inevitably under dangerous voltage. Work on the electrical systems or components may only be carried out by electricians or by individuals who have been instructed how to do so. Working under the guidance and supervision of an electrician in accordance with electrotechnical regulations.

WARNING: ALWAYS REFER TO STANDARDS

When working in potentially explosive areas, pay attention to European Standards EN 60079-14 “Installing Electrical Systems in Explosion Endangered Areas” and EN 60079-17 “Inspection and Maintenance of Electrical Installations in Explosion Endangered Areas”. Working in potentially explosive areas is subject to special regulations (European Standard EN 60079-17), which must be complied with. Any additional national regulations must be needed.

3.2 Serial Number and Type Label

Each actuator of the RTS Fail-Safe Linear FL series carries a serial number. The serial number begins with the year and that can be read from the type label (see Figure 4) of the actuator (the type label is located next to the handwheel – see Figure 5).

Using this serial number, Emerson can uniquely identify the actuator (type, size, design, options, technical data and test report).

Figure 4 Bettis RTS Tag and Serial Number





Type: FL-15B-1MHBB		
No.: 18113E04559		1026
Close: 15,0kN		2018
Open: 15,0kN	Tamb-40..+60°C	
50,0mm	8,3-240sec	 II 2 G Ex de IIC T4 Gb
0,21-6,0mm/sec	IP68	TÜV-A16ATEX0007X
I _N : 0,84-0,67A		LC16.13198-1S
3x380-480V 50/60Hz		us AEx de IIC T4 Gb
S2-15min		IECEX LC 17.0003X
S4-1200c/h - 40%ED		Ex de IIC T4 Gb
19200 Northwest Fwy, Houston, TX 77065		Class 1 Div 1 & 2 Group A
		181148/1

Figure 5 Label 1 - Type Label



3.3 Operating Mode

RTS Fail-Safe Linear FL actuators are suitable for open-loop control (S2 operating mode - on/off duty) and closed-loop control (S9 operating mode - modulating duty) according to EN 60034-1.

3.4 Protection Class

RTS Fail-Safe Linear FL actuators come by default with IP 68 (EN 50629) protection.

CAUTION: PROTECTION CLASS AND CABLE GLANDS

The protection class specified on the type label is only effective when cable glands also provide the required protection class, the cover of the connection compartment is carefully secured and the mounting position (see Section 3.5) is observed.

We recommend metallic threaded cable glands with a metrical thread. Unused cable inlets must be closed with stopping plugs. On explosion-proof actuators, cable glands with protection class **EEx e according EN60079-7** must be used. After removing covers for assembly purposes or adjustment work, take special care upon reassembly so that seals are not damaged and remain properly fastened. Improper assembly may lead to water ingress and to failures of the actuator.

NOTE:

The cover of the control unit - the Operating unit - (see Figure 1) must not be opened.

Allow a certain sag in the connector cables before reaching the screwed cable glands so that water can drip off from the connector cables without running to the screwed cable glands. As a result, forces acting on the screwed cable glands are also reduced. (see Section 3.5)

3.5 Mounting Position

Generally, the installation position is irrelevant. However, based on practical experience, it is advisable to consider the following for outdoors use or in splash zones:

- Mount actuators with cable inlet facing downwards
- Ensure that sufficient cable slack is available

3.6 Direction of Rotation

Unless specifically ordered otherwise, the standard direction is (see Figure 6 and Figure 7):

- **Right turning (clockwise) = CLOSING**
- **Left turning (counter clockwise) = OPENING**

Figure 6 Clockwise = Close

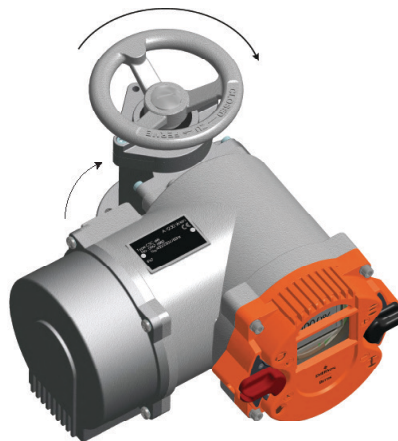
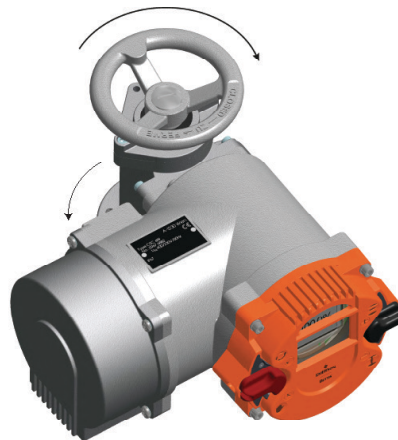

Figure 7 Counterclockwise = Close



 **CAUTION: OBSERVE DIRECTION OF ROTATION**

All specifications in this operating manual refer to the standard direction of rotation.

3.7 Protection Devices

3.7.1 Torque

RTS Fail-Safe Linear FL actuators provide electronic torque monitoring. The switch off torque can be modified in the menu of the controller for each direction separately. By default, switch off torque is set to the ordered value. If no torque was specified with the order, the actuator is supplied from the factory with the maximum configurable torque. For more information, (see Section 8.2).

3.7.1 Motor Temperature

All RTS Fail-Safe Linear FL actuators are normally equipped with motor winding temperature sensors, which protect the motor against excessive winding temperature. The display will show the corresponding error upon exceeding the permissible motor temperature (see Section 3.1).

3.7.3 Input fuse, thermal fuse

The frequency inverter is protected by an input fuse and the explosion proof version by a thermal fuse. If one of the fuses releases, a serious defect occurs and the frequency inverter must be replaced.

3.8 Ambient Temperature

Unless otherwise specified upon ordering, the following operating temperatures apply:

- On/off duty (open-loop control) -25 to +60°C
- Modulating duty (closed-loop control) -25 to +60°C
- Explosion-proof version -20 to +40°C (acc. EN60079-0)
- Explosion-proof version with extended temperature range -40 to +60°C

 **CAUTION: OBSERVE OPERATING TEMPERATURE**

The maximum operating temperature can also depend on further order-specific components. Please refer to the technical data sheets to confirm the as-delivered product specifications.

3.9 Delivery Condition of the Actuators

For each actuator, an inspection report is generated upon final inspection. In particular, this comprises a full visual inspection, calibration of the torque measurement in connection with an extensive run examination and a functional test of the microcontroller.

These inspections are conducted and documented according to the quality system and can be made available if necessary. The basic setting of the end position must be performed after assembly on the actuator.

 **CAUTION: OBSERVE COMMISSIONING INSTRUCTIONS**

Commissioning instructions (see Section 5) must be strictly observed. During assembly of the supplied valves at the factory, end positions are set and documented by attaching a label (see Figure 8). During commissioning at the plant, these settings must be verified.

3.10 Information Notice (Tag)

Each actuator is provided with a bilingual tag containing key information, which is attached to the handwheel after final inspection. This tag also shows the internal commission registration number (see Figure 8).

Figure 8 Tag

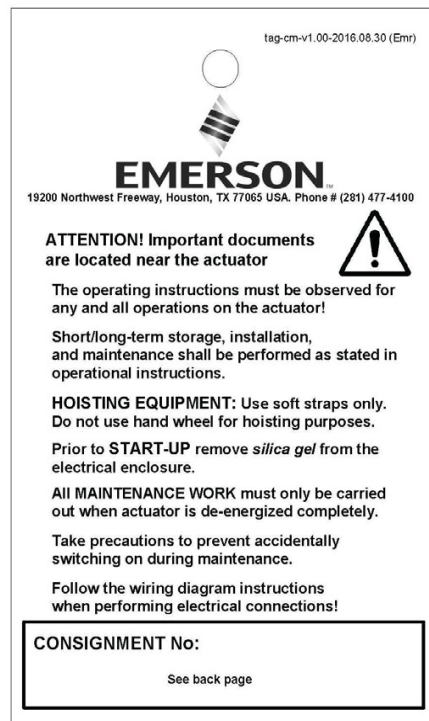

Section 4: Packaging, Transport and Storage

Depending on the order, actuators may be delivered packed or unpacked. Special packaging requirements must be specified when ordering. Please use extreme care when removing or repackaging equipment.

CAUTION: USE APPROPRIATE LIFTING EQUIPMENT

Use soft straps to hoist the equipment; do not attach straps to the handwheel. If the actuator is mounted on a valve, attach the straps to the valve and not to the actuator.

4.1 General

The connection compartment of RTS Fail-Safe Linear FL actuators contains 5g of factory supplied silica gel.

CAUTION: REMOVE SILICA GEL

Please remove the silica gel before commissioning the actuator (see Section 6).

4.2 Storage

CAUTION: OBSERVE PROPER STORAGE

- Store actuators in well-ventilated, dry premises
- Protect against floor dampness by storing actuators on wooden grating, pallets, mesh boxes or shelves
- Protect the actuators against dust and dirt with plastic wrap
- Actuators must be protected against mechanical damage
- The storage temperature must be between -20°C - +40°C

It is not necessary to open the controller of the actuator for servicing batteries or similar operations.

4.3 Long-term Storage

CAUTION: 6 MONTHS OF STORAGE

If you intend to store the actuator for over 6 months, also follow the instructions below:

- The silica gel in the connection compartment must be replaced after 6 months of storage (from date of delivery)
- After replacing the silica gel, brush the connection cover seal with glycerine. Then, carefully close the connection compartment again
- Coat screw heads and bare spots with neutral grease or long-term corrosion protection
- Repair damaged paintwork arising from transport, improper storage, or mechanical influences
- For explosion-proof actuators, it is not allowed to extensively overpaint the actuator. According to the standard, in order to avoid electrostatic charge, the maximum thickness of the varnish paint is limited to 200 μm .
- Every 6 months, all measures and precautions for long term storage must be checked for effectiveness and corrosion protection and silica gel renewed
- Failure to follow the above instructions may lead to condensation which can damage to the actuator

Section 5: Installation Instructions

Installation work of any kind of actuator may only be performed by qualified personnel.

5.1 Mechanical Connection

Check:

- Whether valve flange and actuator base match-up.
- If the bore of the coupling piece coincides with the spindle pin and sufficient thread engagement is available.

Make sure the fitting is in the same position as the actuator:

- For a “fail-safe opener” actuator, the valve has to be completely open.
- For a “fail-safe closer” actuator, the valve has to be completely closed.

In general, refer to the following instructions:

- Clean the bare parts on the actuator coated with rust protectant.
- Clean the mounting surface for the fitting thoroughly.
- Lightly grease the valve stem.
- Set the actuator in place.
- Make sure of centered positioning and that the contact surface of the flange is full.
- Fasten the actuator with suitable bolts:
 - Minimum strength grade: 8.8 or A2-70
 - Ensure sufficient thread engagement (min. 1xd)

CAUTION: AVOID USING TOO LONG SCREWS

Screws that are too long may go against the thread root, creating the risk of the actuator moving radially in relation to the fitting. This may lead to the bolts shearing off.

NOTE:

Unsuitable bolts may result in the actuator falling off.

- Tighten bolts to the correct torque, alternating between bolts on opposite sides.

Table 1. Thread Table (1)

Thread	Tightening Torque [Nm] for Bolts with Strength Grade	
	8.8	A2-70 / A4-70
M6	11	8
M8	25	18
M10	51	36
M12	87	61
M16	214	150
M20	431	294
M30	1489	564

 **CAUTION: PREVENT ACTUATOR OVERSPEEDING**

Valve or piping may be damaged due to high actuating speed.

5.2 Mounting of Linear Fail-Safe Actuator

Emerson Bettis RTS FL Fail-Safe Linear electric actuators move the stem of valve to the failsafe position in case of failsafe event. In general stem of actuator is at failsafe position at delivery! Depending on valve has to be closed or opened by force (sealing force is required in failsafe position) or by travel (actuator shall stop before touching the seat), mounting procedure has to be done different:

5.2.1 Mounting procedure for valve without required sealing force:

- Connect mounting kit to valve and fix according valve producer specification
- Be sure stem of valve is exact in desired failsafe end position
- Be sure stem of actuator is in failsafe position: actuator must not be electrically connected. Handwheel must not be engaged (if applicable, refer to Section 6.2 Manual Operation)
- Mount actuator to mounting kit and fix with 4 screws
- Check distance between end of stem of actuator and end of stem of valve: allowed range of distance is 2 – 25mm
- Connect both stems with coupling and note symmetrical engagement of both threads
- Fix coupling with 4 screws and note both halves of coupling have to be parallel after tighten the screws

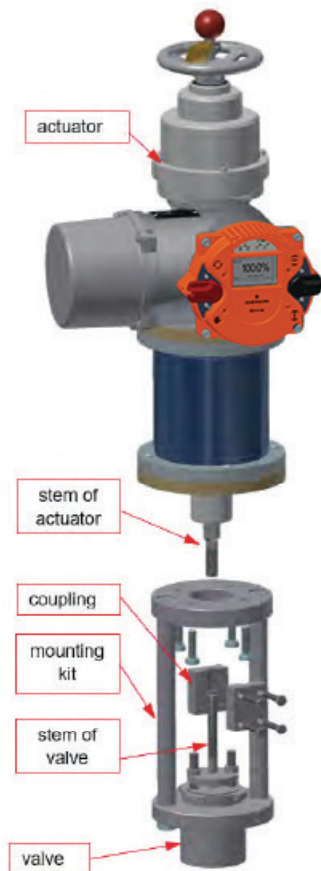
Figure 9 Linear Fail-Safe (1)**5.2.1 Mounting procedure for valve with required sealing force:**

- Connect mounting kit to valve and fix according valve producer specification
- Be sure stem of valve is exact in desired failsafe end position
- Stem of actuator has to be moved 2-5mm away from failsafe position by using handwheel (if applicable, refer to Section 6.2 Manual Operation)
If actuator is not equipped with hanwheel switch to alternative procedure
- Mount actuator to mounting kit and fix with 4 screws
- Check distance between end of stem of actuator and end of stem of valve: allowed range of distance is 2 – 25mm
- Connect both stems with coupling and note symmetrical engagement of both threads
- Fix coupling with 4 screws and note both halves of coupling have to be parallel after tighten the screws

5.2.1 Alternative procedure for valve with required sealing force:

- Connect mounting kit to valve and fix according valve producer specification
- Be sure stem of valve is exact in desired failsafe end position
- Loosen hexagonal nuts of mounting kit and generate a gap of 3-5 mm between flange and pillar
- Mount actuator to mounting kit and fix with 4 screws
- Check distance between end of stem of actuator and end of stem of valve: allowed range of distance is 2 – 25mm
- Connect both stems with coupling and note symmetrical engagement of both threads
- Fix coupling with 4 screws and note both halves of coupling have to be parallel after tighten the screws
- Finally retighten hexagonal nuts symmetrical until gap disappears
Attention: Actuator must not be electrically connected! And handwheel must not be engaged (if applicable, refer to Section 6.2 Manual Operation)

Figure 10 Linear Fail-Safe (2)

5.3 Mounting Position of the Operating Unit

The mounting position of the operating unit can be rotated in 90° steps.

Figure 11 RTS FL Fail-Safe Control Unit

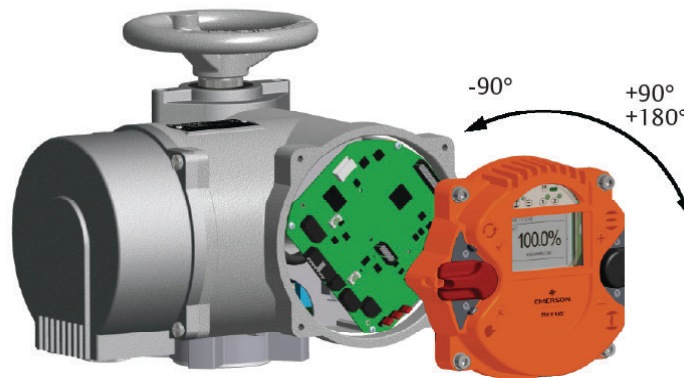

- Disconnect the actuator and control system from the power supply.
- To prevent damage to the electronic components, both the control system and the person have to be grounded.
- Undo the bolts for the interface surface and carefully remove the service cover.
- Turn service cover to new position and put back on.
 - Ensure correct position of the O-ring.
 - Turn service cover by maximum of 180°.
 - Put service cover on carefully so that no cables get wedged in.
- Tighten bolts evenly in a crosswise sequence.

NOTE:

Maximum torque of 5 Nm.

5.4 Electrical Connection

CAUTION: ELECTRICAL CONNECTIONS

Electrical connections may only be carried out by qualified personnel. Please observe all relevant national security requirements, guidelines, and regulations. The equipment should be de-energized before working on electrical connections. As a first step connect the ground screw and confirm the absence of electrostatic discharge during connection.

The line and short circuit protection must be done on the system side.

The ability to unlock the actuator is to be provided for maintenance purposes. For the dimensioning the rated current is to be used (see Technical Data).

Check whether the power supply (voltage, frequency) is consistent with the connection data (see name plate - Figure 4)

The connection of electrical wiring must follow the circuit diagram. This can be found in the appendix of the documentation. The circuit diagram can be ordered from Emerson by specifying the serial number.

When using options, such as a Profibus connection, the relevant guidelines must be followed.

5.4.1 Power Supply Connection

RTS Fail-Safe Linear FL actuators feature an integrated motor controller, i.e. only a connection to the power supply is required. In non explosion-proof actuators, the wiring uses a connector independent from control signals (see Figure 12).

Figure 12 Enclosure Parts

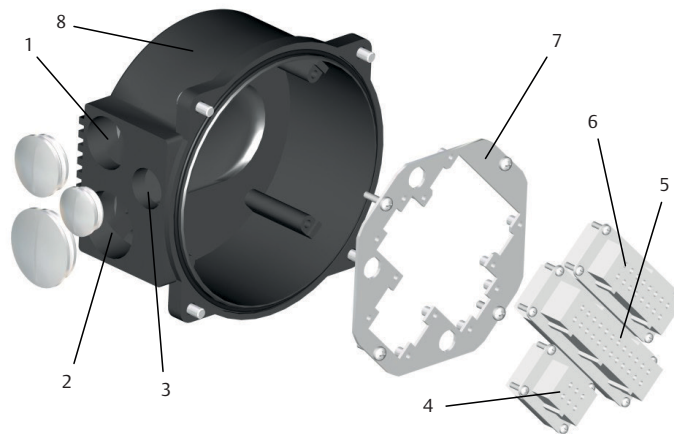

Parts Overview:

1. Metric screw M32x1,5
2. M40x1,5, 3. . . M25x1,5
3. M25x1,5
4. Plug insert (for power supply)
5. Plug insert (for control cables)
6. Connector for options
7. Connector Plate
8. Connecting Housing

Explosion-proof actuators or on special request the connection will be made via terminals (see Figure 13).

Figure 13 Bettis RTS Terminal Box

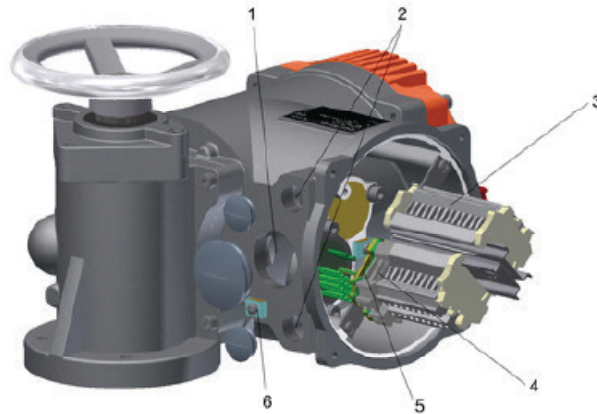

Terminal Box Overview:

1. Metric screw M40x1,5
2. 2 x M20x1,5
3. M25x1,5
4. Terminals for the power supply
5. Terminal for ground connection
6. Outside ground connection

CAUTION: OBSERVE CORRECT PROCEDURE

If, during outdoor installation, commissioning is not carried out immediately after electrical connection, the power supply must be connected at a minimum to achieve a heating effect. In this case, the silica gel may remain in the connection compartment until commissioning. (see Section 3.3)

Section 6: Commissioning

It is assumed that the actuator has been installed and electrically connected correctly. (See Section 5).

NOTE:

Remove silica gel from the alarm cover.

6.1 General Information

NOTE:

When commissioning and each time after dismantling the actuator, the positions have to be reset (see Section 6.4).

6.2 Manual Operation

6.2.1 Standard Version of Actuator

Actautors cannot be manually operated.

6.2.1 Actuator with Additional Option Manual Mode

The manual operation of the linear actuator allows an adjustment of the valve when powered-off.

CAUTION: MANUAL DRIVE OPERATION

- By activating the manual drive is the fail-safe function is disabled.
- By activating the manual drive the electrical function of the drive is disabled.

In normal operation, the handwheel (9) has no effect, it rotates idly by.

NOTE:

The manual mode can be activated only when the drive is in the fail-safe position. To activate manual mode, the padlock has to be removed, and the coupling rod can be pushed all the way into the drive. For easier clutch engagement move the handwheel easily back and forth. Through the engagement of the actuator is automatically electrically disabled:

- Display "Manual Operation".
-

Figure 14 RTS FL Fail-Safe Actuator Handwheel Rotation

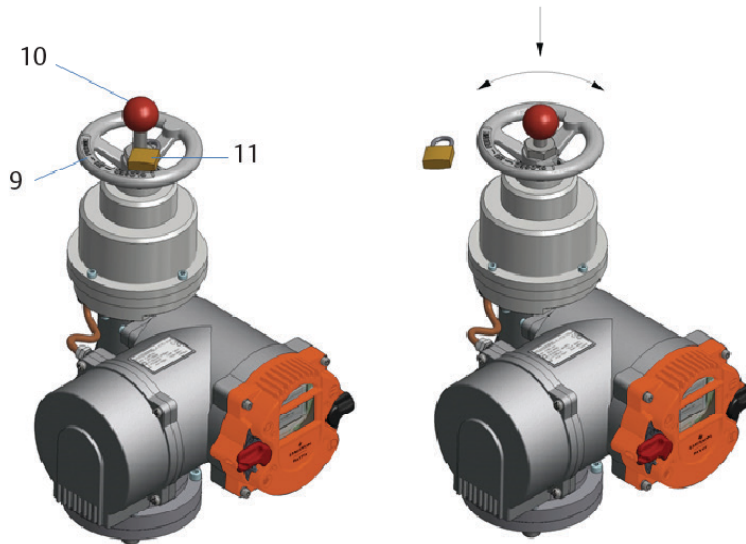

Parts Overview:

- Handwheel
- Coupling Rod
- Padlock

Handwheel Rotation:

- Handwheel clockwise rotation = Retract the actuator stem
- Handwheel counterclockwise rotation = Extend actuator stem

To exit the manual mode and enable the actuator again for the automatic mode ensure that:

- The actuator be driven in the fail-safe position by handwheel.
- The coupling rod be pulled up to the stop of the actuator.
- The coupling rod again secured with the padlock.

6.3 Mechanical Default Settings and Preparation

The use of multi-turn sensors makes mechanical settings unnecessary.

CAUTION: ADJUST TORQUE BEFORE OPERATION

Before the motorised operation of the valve, it is essential to check and adjust torque settings.

6.4 End Limit Setting

A detailed description of the operation of the RTS Fail-Safe Linear FL controller can be found in Section 7.2.

6.4.1 End limit OPEN

Step 1 - Set the selector switch and control switch to the centre position.

Figure 15 Switches in Center Position

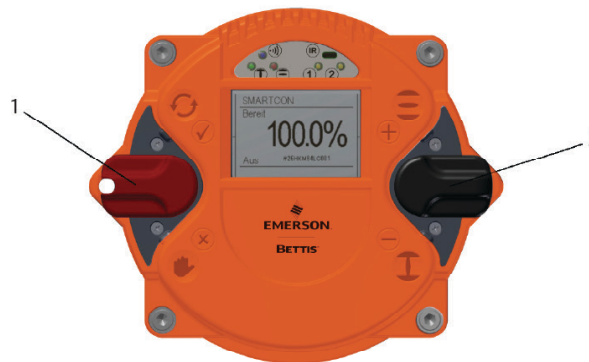

Terminal Box Overview:

1. Selector Switch (Red)
2. Control Switch (Black)

Step 2 - Scroll through the menu with the control switch. Move the control switch towards the first menu item "P 1.1 End limit – Open".

Figure 16 Control Switch End Limit Open



Figure 17 Front Display for End Limit Open

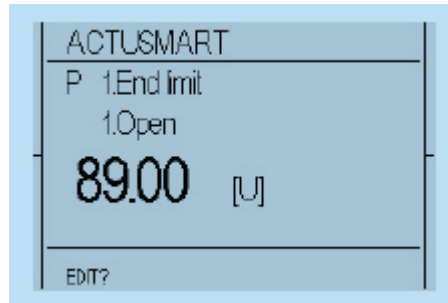

Step 3 - Afterwards, flip up the selector switch slightly and let it snap back to its neutral position. ☑

Figure 18 Selector Switch Setting (1)

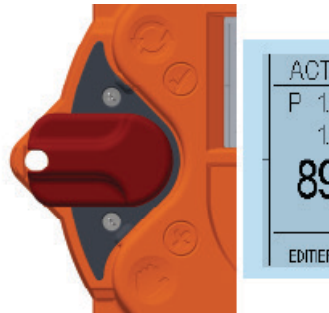

Figure 19 Selector Switch Setting (2)

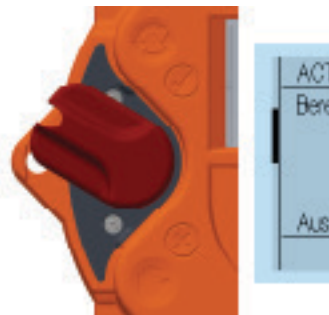
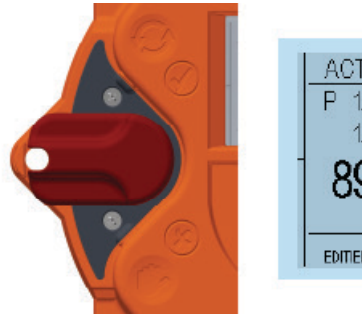
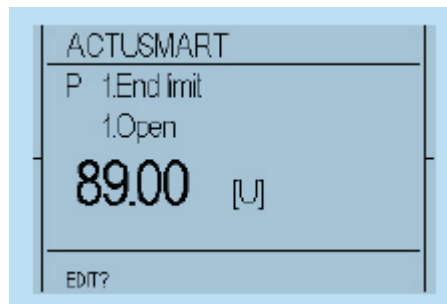
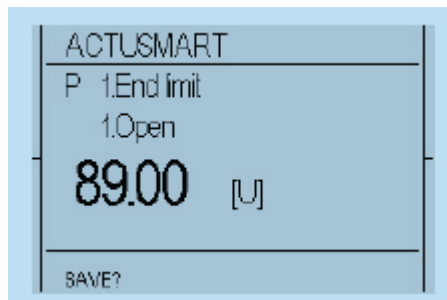

Figure 20 Selector Switch Setting (3)

Step 4 - This changes the bottom line of the display from "EDIT?" to "SAVE?"

Figure 21 Edit and Save**Figure 22** Save Settings

Step 5 - Then, push down the selector switch until it snaps into place. In doing so, the bottom right now on the display will show "TEACHIN" with a warning icon.

CAUTION: USE OPERATING SWITCH

Once the display shows "TEACHIN", use the control switch (black switch) to start the motorised operation of the actuator. In this mode, no travel-dependent switch off occurs in the end position.

CAUTION: CHECK MAXIMUM PARAMETERIZED TORQUE

Please note that, during motor operation, only torque monitoring remains active, as travel adjustment will happen subsequently. Therefore, please check beforehand whether the maximum torque has been already parameterised.

Step 6 - Absolute and relative values on the display will change continuously along with position changes.

Figure 23 Position Change Selector Setting

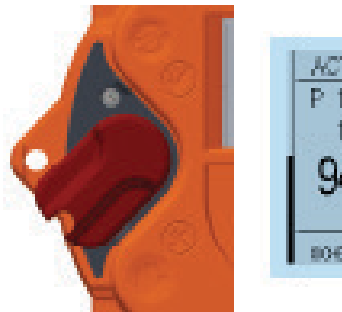
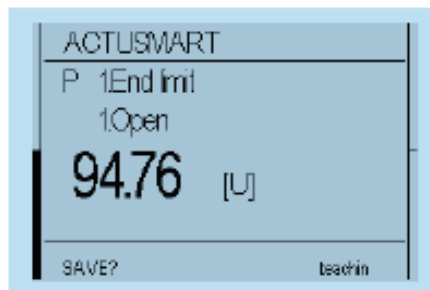

Figure 24 Position Change Display



Step 7 - Manually move the actuator with the handwheel (see Section 2.1, or 2.6) or by motor via the control switch (black button) to the end position OPEN of the valve.

- Absolute value: Absolute value of the position feedback
- Relative value: the value to the other end position

Figure 25 Absolute Value

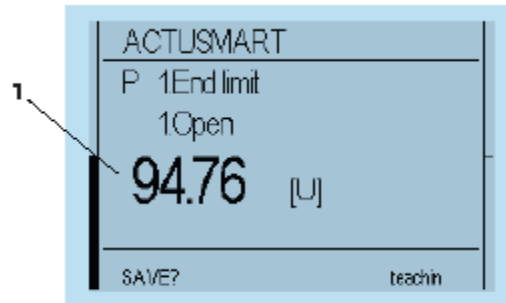

Display Overview:

1. Absolute value

Step 8 - When the desired end position OPEN of the valve is reached, move the selector switch back to the middle position. Thus, the line "TEACHIN" disappears.

Figure 26 Selector for End Position (Save)

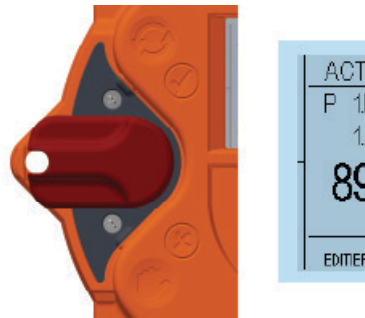
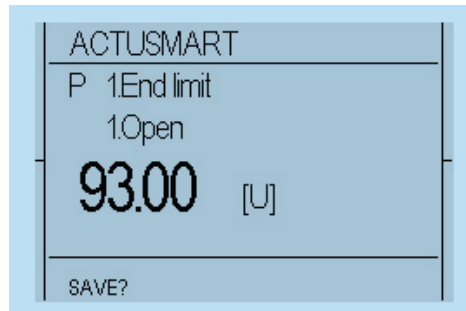

Figure 27 End Position Display



Step 9 - In order to confirm the end position (save), slightly flip up the selector switch towards ☑ and let it snap back to its neutral position.

Figure 28 Selector Setting Save (1)

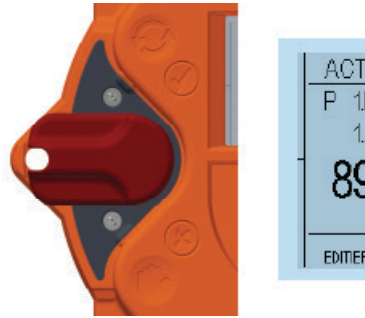

Figure 29 Selector Setting Save (2)

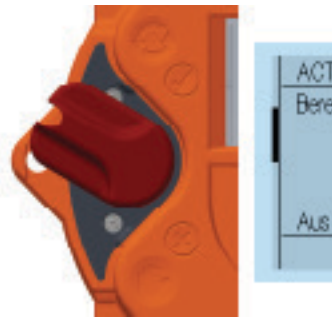
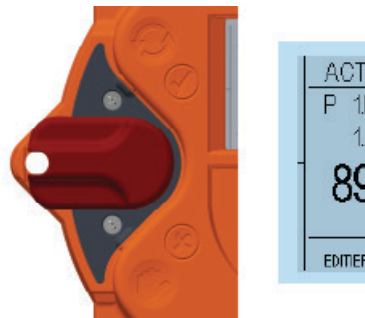

Figure 30 Selector Setting Save (3)



Step 10 - This changes the bottom line of the display for "SAVE?" to "EDIT?" and the end position is stored.

Figure 31 Selector Setting Display (1)

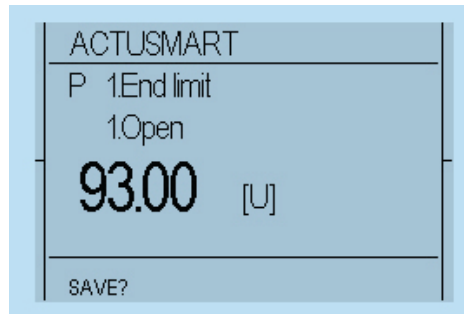
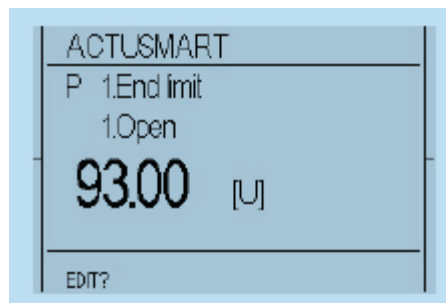

Figure 32 Selector Setting Display (2)



6.4.1 End limit CLOSE

Repeat 5.4.1 but select "P 1.2 End limit - End limit CLOSE".

6.5 Adjusting of Fail-Safe Speed

Bettis FL Fail-Safe Linear actuators are equipped with an adjustable passive eddy current brake, by which it is possible to change the fail-safe speed. When delivered the fail-safe speed is set to minimum.

After mounting the actuator to valve and test run, fail-safe speed can be increased if necessary.

CAUTION: PREVENT ACTUATOR OVERSPEEDING

Valve or piping may be damaged due to high actuating speed.

6.5.1 Setting Procedure

⚠ CAUTION: NO POWERING UP DURING MAINTENANCE

All adjustment work may only be performed with the actuator disconnected from the power supply. Due to this requirement, the actuator has to be in the fail-safe position. Any powering up must be ruled out during maintenance.

⚠ WARNING: ALWAYS REFER TO STANDARDS

When working in potentially explosive areas, pay attention to European Standards EN 60079-14 “Installing Electrical Systems in Explosion Endangered Areas” and EN 60079-17 “Inspection and Maintenance of Electrical Installations in Explosion Endangered Areas”.

Figure 33 Removing the Cover

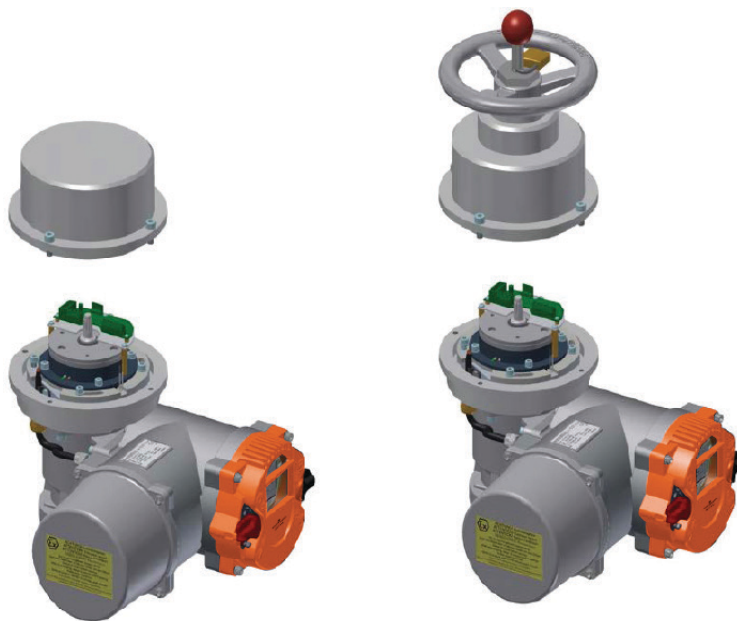

Attention:

In the version with handwheel there is a cable connection which has to be unplugged.

1. Loosen but do not remove 4pcs of screws according Figure 8.
2. Insert 3mm allen key into radial borehole of flange.
3. Turn flange by use of allen key in direction according Figure 8. Half of possible rotating angle will approximately double failsafe speed of actuator. While holding flange with key in desired position retighten screws.
4. In the version with handwheel reconnect the cable to the cover.
5. Remount the cover while be aware of correct position of O-ring sealing.
6. Retest actuator to check for correct failsafespeed.

Figure 34 Adjusting speed

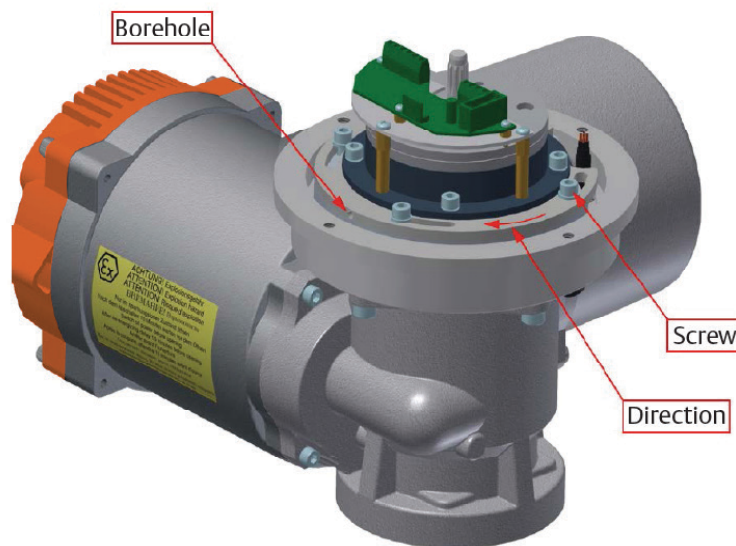

6.6 Final Step

Following commissioning, ensure covers are sealed and cable inlets are closed. Also, check the actuator for damaged paint (by transportation or installation) and take necessary steps to repair if needed.

Section 7: Control Unit

The controller is intended to monitor and control the actuator and provides the interface between the operator, the control system and the actuator.

7.1 Operating Unit

Operation relies on two switches: the control switch and a padlock-protected selector switch. Information visualization is provided by 4 integrated indicator lights, as well as the graphic display. For better visibility, switch symbols (☑, ☒, ⊕, ⊖) are on the cover.

Figure 35 Operating Unit Controls

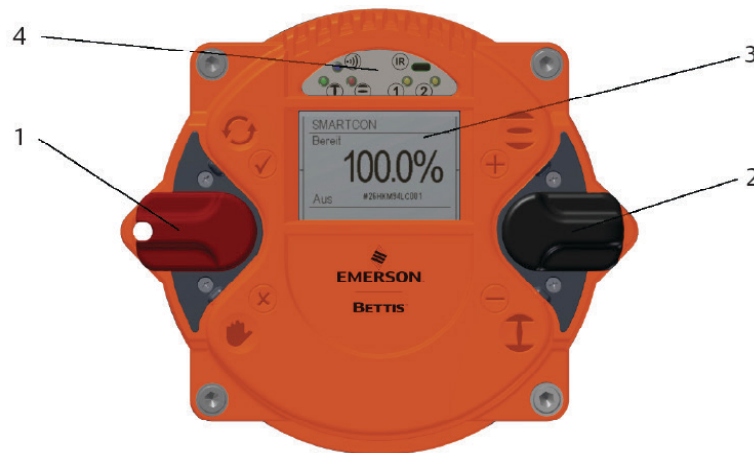

Display Overview:

1. Selector Switch
2. Control Switch
3. Graphic Display
4. LED Display

The control switch has dual function.

The controller cover may be wiped clean with a damp cloth.

The mounting position of the control unit can be turned in 90° steps (see Section 4.2).

7.2 Display Elements

7.2.1 Graphic Display

The graphic display used in the controller allows text display in different languages.

Figure 36 Display (1)

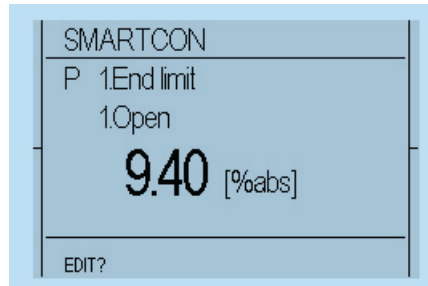

During operation, the displays shows the position of the actuator as a percentage, operation mode and status. When using the option "identification", a customer-specific label is shown at the bottom of the display (e.g., PPS Number).

Figure 37 Display (2)

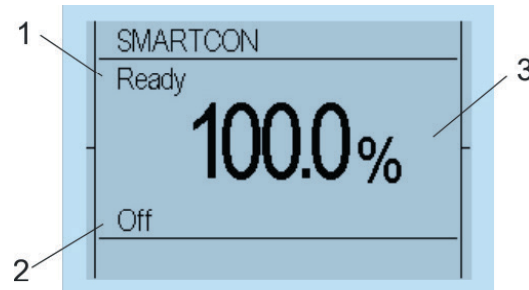

Display Overview:

1. Status
2. Operation Mode
3. Position

7.2.1 LED Display

To provide users with better status information, basic status data is displayed using 4 color LEDs. As the device powers up, it undertakes a self-test whereby all 4 LEDs briefly lit up simultaneously.

Figure 38 LED Display

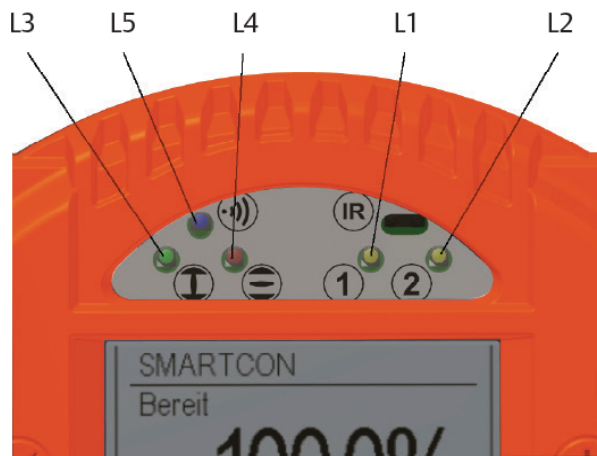

Table 2. LED Colour Legend

Description	Colour	Lits up	Flashes quickly	Flashes slowly	Does not light up
L1	Yellow	No torque error	Torque fault	—	—
L2	Yellow	Ready (operational readiness)	Path error (no operational readiness!)	—	Error (no operational readiness) motor temperature, supply voltage absent, internal error
L3 ⁽¹⁾	Red	OPEN	Moving to OPEN position	Applies upon torque-dependent opening: Occurs when the end position OPEN is reached but the cut-out torque has not yet been reached	Actuator is not in the open position.
L4 ⁽¹⁾	Green	Closed	Moving to CLOSED position	Applies upon torque-dependent closing: Occurs when the end position CLOSED is reached but the cut-out torque has not yet been reached	Actuator is not in the closed position.
L5	Blue	Bluetooth enabled	Bluetooth data transmission	Bluetooth ON, no data transmission	Bluetooth/Infrared OFF
	Red	Infrared ON	Infrared data transmission	Infrared ON	

7.3 Operation

The actuator is operated via the switches located on the controller (selection and control switch). All actuator settings can be entered with these switches. Furthermore, configuration is also possible via the IR interface or the Bluetooth Interface (see Section 11). Flip the switch up or down to regulate the parameter menu scrolling speed.

Figure 39 Neutral Position

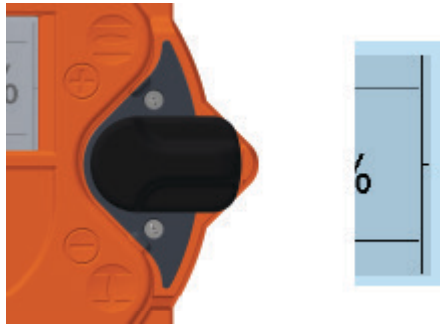

Figure 40 Slight Switch Flip (It Will Move to the Next Parameter)

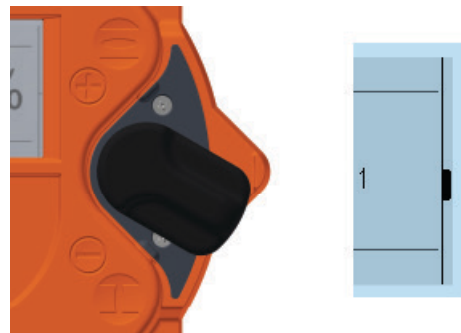

Figure 41 Halfway Switch Flip (Jump to the Next Parameter Category)

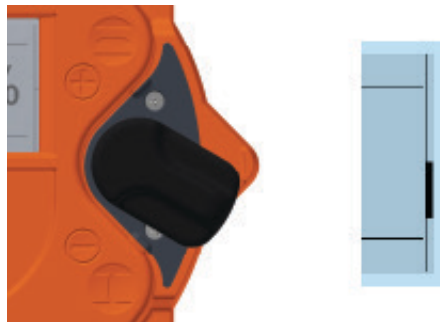
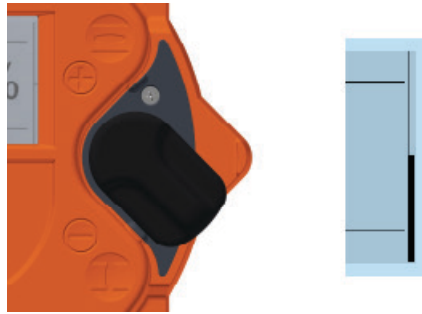

Figure 42 Full Switch Flip (Jump to the End of the Menu)





7.3.1 Operation mode

Use the selector switch (red) to determine the various operating states of the actuator. In each of these positions, it is possible to block the switch by means of a padlock and thus protect the actuator against unauthorized access.

The selector switch has the following positions:

Table 3. Selector Positions

Position	Function
OFF	The actuator can be neither operated via the remote control nor via the control switches of the controller.
Local 	It is possible to operate the actuator by motor via the control switch. Control via the remote inputs may be possible with appropriate configuration (superimposed control commands, emergency commands)
Remote 	The actuator is ready to process control commands via input signals. The control switch for the motor operation of the actuator is disabled.

Besides defining the operational status, the selector switch is used in configuration mode to confirm or cancel parameter inputs.

Depending on the selector switch position, the control switch performs different functions:

Table 4. Control Switch Positions

Position	Function
Selector switch in the OFF position:	The control switch is used to scroll up or down through the menu according to internal symbolism. From the neutral position towards ⊕ you reach the status and history data areas. Towards the ⊖ symbols you reach the parameter menu. Here, the selection switch either confirms ✓ or rejects ✗ the current input according to associated symbolism.
Selector switch in the REMOTE position ⊕:	The control switch gives you access to status, history data and parameter area.
Selector switch in the LOCAL position ⊖:	With the control switch, the actuator can be operated by motor. You may also operate the actuator in inching and self-hold mode. Switches are spring-loaded to snap back automatically into their neutral position. (To confirm a control command, the control switch must be pushed all the way into its mechanical locking position.)

7.3.1 Configuration

In principle, all parameters are shown as numbers in the corresponding parameter point. From the actuator menu, use the control switch to access different menu points. The lower left corner of the display shows the "EDIT" option.

Figure 43 Configuration Display (1)

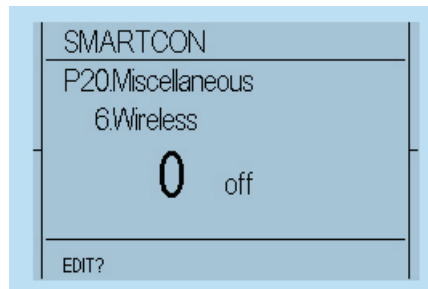





Confirm the selector switch (with a slight flip upwards, towards , (see Figure 28, to Figure 32) to change the selected parameter. To confirm this input readiness, the display changes from "EDIT" to "SAVE".

Figure 44 Configuration Display (2)

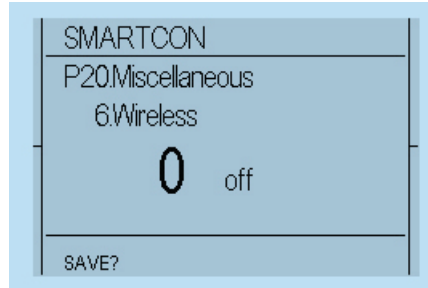

Move the control switch towards to the characters to change the parameter.  or  (see Figure 39 to Figure 42). After reaching the desired parameter value, confirm the value with the selector switch (again, flip it slightly towards , (see Figure 28 to Figure 30).

7.3.2 Configuration example

As an example, we will change parameter P20.6 (wireless) from 0 (wireless off) to 2 (Bluetooth communication on). Thus, the Bluetooth connection is activated for a short time and then deactivated again automatically:

Step 1 - The operating and control switch must be in the neutral position.

Figure 45 Selector Switch (1, Red); Control Switch (2, Black)

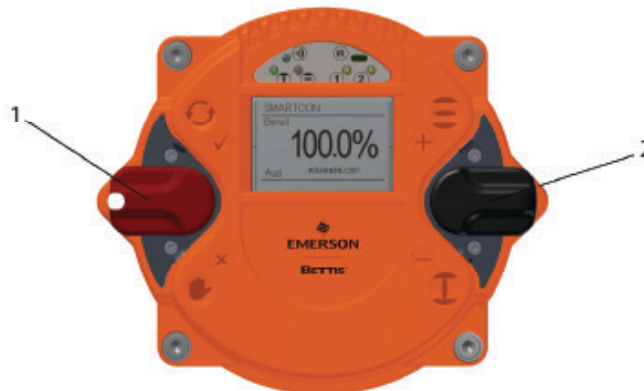

Step 2 - Now, move the control switch down (towards ) until the menu item "P 20.6 Miscellaneous - Wireless" is displayed.

Figure 46 Control Switch Flipped Down

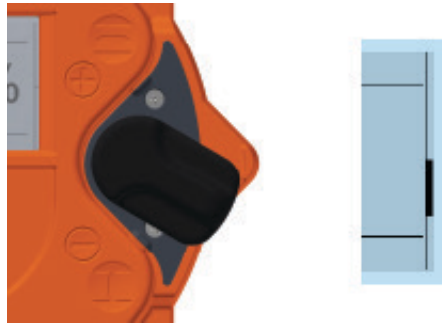
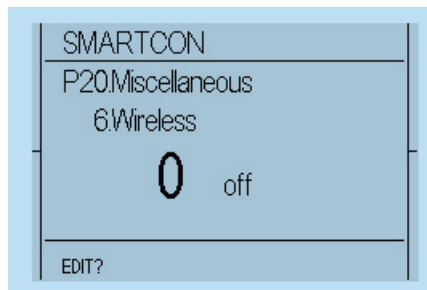

Figure 47 Display (1)



Step 3 - Afterwards, flip up slightly the selector switch (towards) and let it snap back to its neutral position:

Figure 48 Selector Switch in Neutral Position

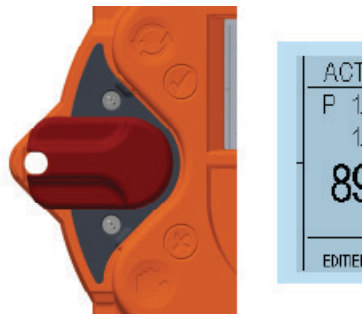

Figure 49 Selector Switch Flipped Up

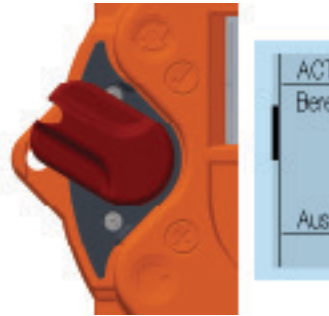
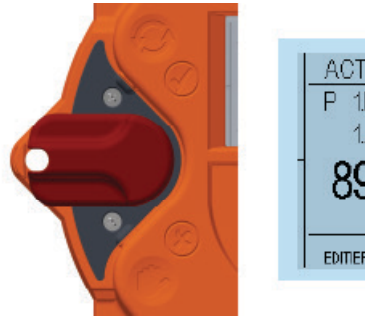

Figure 50 Selector Switch in Neutral Position



Step 4 - This changes the bottom line of the display from "EDIT?" to "SAVE?".

Figure 51 Display (2)

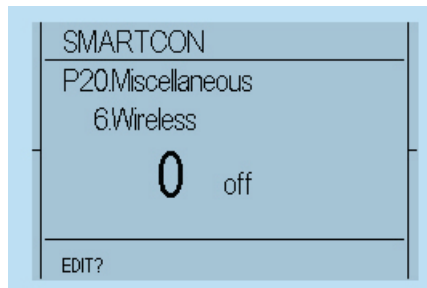
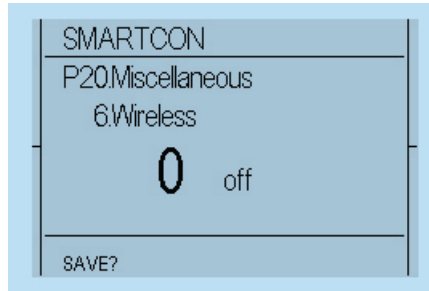

Figure 52 Display (3)



Step 5 - Flip up the control switch (toward) to change the value from 0 (off) to 2 (Bluetooth).

Figure 53 Control Switch Flipped Up

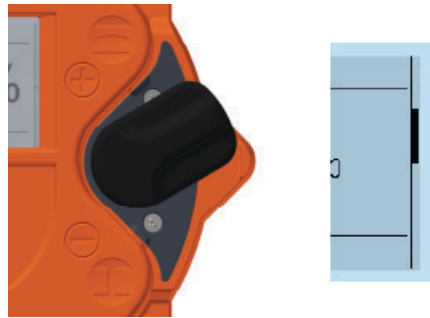
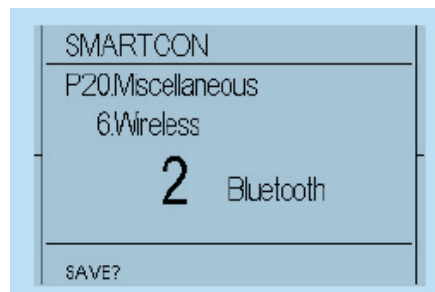

Figure 54 Switch to One



Step 6 - If the value changes to 1, confirm the selection by flipping halfway up the selector switch (towards) and letting it snap back to its neutral position (see Figure 42 to Figure 46).

Figure 55 Selector Switch Flipped Halfway Up

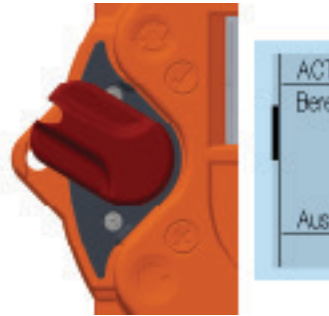
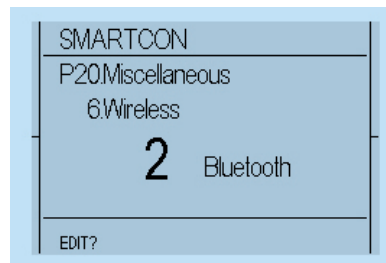

Figure 56 Display After Confirming Selection



Step 7 - This changes the bottom line of the display from "SAVE?" to "EDIT?" and the parameter is stored.

7.3.2 "TEACHIN"

Furthermore, certain parameters (end positions, intermediate positions), can be set using "TEACHIN". Thus, their configuration is greatly simplified.

After selecting the appropriate menu item (for example: End position) and changing the the input type from "EDIT?" to "SAVE?", move the selector switch (red) to "manual mode" and lock it into place. As you do so, the display will show the message "TEACHIN" and the current position value will be applied continuously to the parameter value. In this mode, further to manual operation by hand wheel, the actuator can be motor-driven with the control switch to the desired position. (see Section 5.4.1)

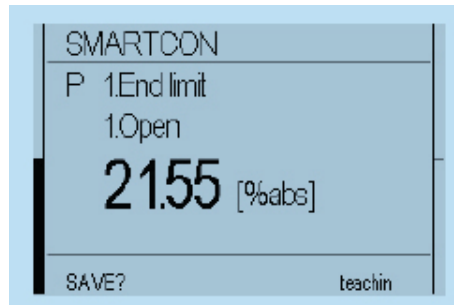
Figure 57 'Teachin' on Display

 CAUTION: MAXIMUM TORQUE MUST BE ALREADY SET

Please note that, during motor operation, only torque monitoring remains active, as travel adjustment will happen subsequently. Therefore, please check beforehand whether the maximum torque has been already set.

After reaching the desired, position, move the selector switch back to the neutral position. Finally, the parameter value must still be saved by flipping the selector switch halfway up and letting it snap back to the neutral position (see Figure 48 to Figure 52).

Section 8: Parameter Menu

For each parameter group, you can find a description, tabular overview of the menu items and possible configurations. The parameter list below also includes all possible options per menu item. Please note that some of the menu items listed and described may not be available with your configuration.

8.1 Parameter Group: End Limit

These parameters are used to configure the end position and switch off behavior of the actuator. It is important to ensure that the basic mechanical configuration described in Section 15.4 has already been made.

NOTE:

Ensure that these parameters are set during commissioning before operating the actuator. In addition, the settings in the "Torque" menu (see Section 17.2) must be compared with the permissible values of the valve and corrected as appropriate.

 CAUTION: PROPER ACTUATOR POSITION

100% stands for fully open and 0% for fully closed. Please note that these values cannot be changed.

Table 5. End Limit Table (1)

	Menu Item	Sub Menu Item	Position Setting	Notes /Comments
P1.1	End limit	Open	TEACHIN; 0-100U ¹⁾	The parameter value can be set using "TEACHIN". With a known travel, the second end position can be entered after setting the first end position.
P1.2	End limit	Close	TEACHIN; 0-100U ¹⁾	The parameter value can be set using "TEACHIN". With a known travel, the second end position can be entered after setting the first end position.
P1.3	End limit	Switch off Open	by travel (0)	The actuator uses end position signals to switch off and report the end position.
			by torque (1)	The actuator signals the end position or stops the motor only after reaching the specified torque with the provision that it has reached the end position. If the end position signal is not reached, the actuator reports an error.
			by torque1 (2)	Like torque, but in the end position range, this is also extended when the positioning command is released, until the torque is reached.
			by torque2 (3)	Like torque1, however, an actuating command is automatically generated additionally in the end position range so that the end position in the end position range is approached even without a positioning command.
			by torque3 (4)	Like travel, however, the actuator still continues to drive the set Overrun time after reaching the end position, even when the positioning command is released. Only relevant if Overrun time (P1.10, P1.11) is greater than 0.

Table 6. End Limit Table (2)

	Menu Item	Sub Menu Item	Position Setting	Notes /Comments
P1.4	End limit	Switch off Close	by travel (0)	The actuator uses end position signals to switch off and report the end position.
			by torque (1)	The actuator signals the end position or stops the motor only after reaching the specified torque with the provision that it has reached the end position. If the end position signal is not reached, the actuator reports an error.
			by torque1 (2)	see P1.3
			by torque2 (3)	see P1.3
			by torque3 (4)	see P1.3
P1.5	End limit	Closing directing	right (0)	Actuator is designed for clockwise = closing.
			left (1)	Reverse direction of rotation. Counter clockwise = closing. The crossing of all signals and commands is performed by the controller.
P1.6	End limit	Rotate sense position	0	Rotation sense of the Potentiometer. No function in RTS Fail-Safe Linear FL series.
			1	
P1.7	End limit	LED function	Close = green (0)	Definition of the LED color of the CLOSED or OPEN end position indication.
			Close = red (1)	
P1.8	End limit	End limit hyst.	0.1 - 10.0%	Hysteresis range for end position signals: Example: End position hysteresis 1% means that the End position OFF is reached when closing 0%, and will be left when opening only at 1%, i.e., a re-closing can only take place after leaving this hysteresis.
P1.9	End limit	Ramp	0.1 - 10.0%	When approaching the end position, the speed is reduced.
P1.10	End limit	Range	0 - 10.0%	End position range for torque (P1.3, P1.4). Permissible range in which the torque is to be achieved. If the actuator comes to the end of the end position range, the motor shuts off even if the torque has not been reached.
P1.11	End limit	Overrun Open	0 - 60 s	Switch-off delay after reaching the end position see travel1 (P1.3, P1.4)
P1.12	End limit	Overrun Close	0 - 60 s	Switch-off delay after reaching the end position travel1 (P1.3, P1.4)

CAUTION: OBSERVE LIMITS AND FACTORS OF GEAR

When installing the actuator on an gear or a thrust unit, please take into account the limits and ratio of the gear/thrust unit at parameterization.

When using end limit switch off by torque, the end position limit must be set before reaching the torque limit. Accordingly, the actuator will only signal the final end position if the configured torque and the associated end position are reached. If the end position is not reached, a torque error is reported (see [Section 17.2.2](#)).

8.2 Parameter Group: Torque

If no torque was specified with the order, the actuator is supplied from the factory with the maximum configurable torque.

Table 7. Torque Table

	Menu Item	Sub Menu Item	Position Setting	Notes/Comments
P2.1	Torque	Open	8 - 32Nm ²	Switch off torque in OPEN direction CAUTION: The range can be restricted via the menu item P2.3
P2.2	Torque	Close	8 - 32Nm ²	As P2.1 but in CLOSED direction
P2.3	Torque	Torque limit	8 - 32Nm ²	Torque to protect the valve, the gear box or the thrust unit. This value limits the setting of the Parameters P2.1 and P2.2 and to prevent an erroneous increase above the allowed value of these two parameters.
P2.4	Torque	Latching	{Off (0)}	Unassigned in RTS FL
P2.5	Torque	Boost Open	{0%}	Unassigned in RTS FL
P2.6	Torque	Boost Close	{0%}	Unassigned in RTS FL
P2.7	Torque	Hysteresis	{0: 50%}	Unassigned in RTS FL

CAUTION: OBSERVE CORRECT VALUE OF GEAR

When installing the actuator on a additional gear, please take into account the corresponding values of the gear/thrust unit as you enter the actuator parameters. To achieve an effective output torque (including gear)/output power (including thrust unit) ratio, the ratio of gear/thrust unit must be considered.

8.3 Parameter Group: Speed

Table 8. Speed Table

	Menu Item	Sub Menu Item	Position Setting ²⁾	Notes/Comments
P4.1	Speed	Local Open	2.5 ... 72.2 rpm	Output speed for local operation in direction OPEN
P4.2	Speed	Local Close	2.5 ... 72.2 rpm	As P4.1 but in direction CLOSE
P4.3	Speed	Remote Open	2.5 ... 72.2 rpm	Output speed for remote operation in direction OPEN
P4.4	Speed	Remote Close	2.5 ... 72.2 rpm	As P4.3 but in direction CLOSE
P4.5	Speed	Emergency Open AUF	2.5 ... 72.2 rpm	Output speed for emergency operation in direction OPEN
P4.6	Speed	Emergency Close	2.5 ... 72.2 rpm	As P4.5 but in direction CLOSE
P4.7	Speed	Torque-dependent	2.5 ... 72.2 rpm	Seal-tight speed. Speed at which the actuator runs near the end position at torque-dependent switch off (see P1.3 and P1.4)
P4.8	Speed	Minimum	2.5 ... 72.2 rpm ¹	Minimum speed

²⁾representative for CM03

CAUTION: OBSERVE MAXIMUM SPEED

The maximum speed for the 24VDC actuator version is reduced to 20 rpm.

8.4 Parameter Group: Ramp (optional)

The start ramp can be set separately for each operation mode. Thus, a 100% start ramp means that the motor attains its maximum speed in about a second. Higher speeds (see [Section 18.3](#)) lead to shorter run times. If the ramp is set below 100%, the starting time increases in an inversely proportional fashion.

Table 9. Ramp Table

	Menu Item	Sub Menu Item	Position Setting	Notes/Comments
P5.1	Ramp	Local	5 - 100%	Start ramp for local operation
P5.2	Ramp	Remote	5 - 100%	Start ramp for remote operation
P5.3	Ramp	Emergency	5 - 100%	Start ramp for emergency operation

8.5 Parameter Group: Control

Table 10. Control Table

	Menu Item	Sub Menu Item	Position Setting	Notes/Comments
P6.2	Control	Ready delay	0 - 10s	Drop-out delay for the ready signal (Binary outputs)
P6.5 ³⁾	Control	24V output	0	24V auxiliary output is deactivated (see Section 17.5). The function of the auxiliary input is still activated.
			{1}	24V auxiliary output is activated (see Section 17.5).
P6.6	Control	Min. impuls	0.1 - 2.0 sec	Minimum switch-on time of the motor.

³⁾since firmware 1.303

8.6 Parameter Group: Password

The actuator control can be password-protected to prevent access at different levels. It is possible to prevent entry by unauthorized personnel or to entirely lock motor operation. Default password is set to "000". You can use both numbers and capital letters in your password. After entering a password, password protection is activated. To remove password protection, enter an empty password (000).

When accessing a password-protected parameter, the user is automatically prompted for the password. Only after correctly entering the password, is it possible to change the corresponding parameters.

Table 11. Password Table

	Menu Item	Sub Menu Item	Position Setting	Notes/Comments
P7.1	Password	Reading PWD	3- digit	Status display and history data are still viewable; access to the parameter menu is locked until this password is introduced. Parameter menu scrolling is only enabled after entering the password. Electric motor operation is unlocked.
P7.2	Password	Writing PWD	3- digit	Status display, history data and parameter menu can be viewed. However, parameters become read-only.
P7.3	Password	Bluetooth PWD	15-digit	Password for the Bluetooth connection, empty password deactivates the password request.

8.7 Parameter Group: Position

In addition to OPEN and CLOSED end positions, you can define intermediate positions. These can be used as feedback signals for the binary outputs or as target value for fix position approach.

 CAUTION: END POSITIONS MUST BE OBSERVED

If you change the end positions (see [Section 17.1](#)) intermediate positions are retained percentage-wise, i.e., the absolute positions of the intermediate positions change.

Table 12. Position Table

	Menu Item	Sub Menu Item	Position Setting	Notes/Comments
P8.1	Position	Intermediate position 1	TEACHIN 0 - 100%	Position value of intermediate position 1
P8.2	Position	Intermediate position 2	TEACHIN 0 - 100%	See above
P8.3	Position	Intermediate position 3	TEACHIN 0 - 100%"	See above
P8.4	Position	Intermediate position 4	TEACHIN 0 - 100%	See above
P8.5	Position	Emerge position	TEACHIN 0 - 100%"	Position value of the emergency position.
P8.6	Position	Hysteresis	0.1 - 10.0%	Hysteresis range of intermediate positions. Within this hysteresis, no repositioning occurs upon reaching the intermediate positions (option: fix position approach). Furthermore, the output functions for position = intermediate position are active within this range (see P10.1).

8.8 Parameter Group: Binary Inputs

The controller is equipped with 5 freely configurable binary inputs. Please find further information on technical data of the binary inputs in Section 17.2. Binary inputs are also effective during actuator control via Profibus (option).

Default binary inputs are as follows:

Input 1:	OPEN
Input 2:	CLOSED
Input 3:	STOP
Input 4:	EMERGENCY OPEN
Input 5:	EMERGENCY CLOSED

Table 13. Binary Inputs Table (1)

	Menu Item	Sub Menu Item	Position Setting	Notes/Comments
P9.1	Binary Input	Input 1	0: No Function	This input has no function.
			1: Open	OPEN command in REMOTE mode (selector switch in position REMOTE).
			2: Closed	CLOSED command in REMOTE mode (selector switch in position REMOTE).
			3: Stop	STOP command in REMOTE mode (selector switch in position REMOTE).
			4: Open Self-hold	Self-hold for OPEN, i.e., a short pulse is sufficient and the actuator moves then into the end position. Use the STOP command to stop the actuator.
			5: Closed Self-hold	Self-hold for CLOSED, see OPEN SELF-HOLD
			6: Emergency Open	Superimposed run command; run the actuator in direction OPEN regardless of whether the selection switch is set to REMOTE or LOCAL operation.
			7: Emergency Closed	Superimposed run command; run the actuator in direction CLOSED regardless of whether the selection switch is set to REMOTE or LOCAL operation.
			8: Release	The actuator may be operated only with a switched signal. Both in LOCAL and REMOTE operation.
			9: Open/Closed	The actuator moves towards OPEN if input is active and towards CLOSED otherwise.
			10: Close Open	The actuator moves towards CLOSED if input is active and towards OPEN otherwise.
			11: Positioner	Release of the positioner.
			12: Open inv.	As OPEN but active low.
13: Close inv.	As CLOSED but active low.			

Table 14. Binary Inputs Table (2)

	Menu Item	Sub Menu Item	Position Setting	Notes/Comments
P9.1	Binary Input	Input 1	14: Stop inv.	As STOP but active low.
			15: Open Self-Hold inv.	As Open Self-Hold but active low.
			16: Closed Self-Hold inv.	As Closed Self-Hold but active low.
			17: Emergency-Open inv.	As Emergency-Open but active low.
			18: Emergency-Closed inv.	As Emergency-Closed but active low.
			19: Block	With activated (switched) signal, the actuator is locked for operation also in local mode.
			20: Controller lock	Positioner lock.
			21: Release Local	The actuator may be operated only with a switched signal.
			22: Block Local	As Release Local but active low.
			23: Lock Open	Trigger lock OPEN (in LOCAL and REMOTE mode). Actuator moves with the highest priority to OPEN; command continues internally active after reaching the end position OPEN. Dropping only with LOCK OFF, Supply OFF or operating mode OFF.
			24: Lock Closed	Trigger lock CLOSED (in LOCAL and REMOTE mode). Actuator moves with the highest priority to CLOSED; command continues internally active after reaching the end position CLOSED. Dropping only with LOCK OFF, Supply OFF or operating mode OFF.
			25: Lock Off	Drop the lock.
			26: Fail-safe	Trigger the Fail-safe function in all operating modes (only functional in fail-safe actuators).
			27: Fail-safe inv.	As Fail-safe, but active low.
			28: Lock Open inv.	As Lock Open, but active low.
			29: Lock Closed inv.	As Lock Open, but active low.
			30: Lock Off inv.	As Lock Off, but active low.
31: Intermediate position 1	Approach intermediate position 1 (P8.1) in REMOTE mode (fix position approach). There is no repositioning upon reaching the intermediate position within the hysteresis (see P8.6) Higher priority than intermediate position 2, 3 and 4.			

Table 15. Binary Inputs Table (3)

	Menu Item	Sub Menu Item	Position Setting	Notes/Comments
P9.1	Binary Input	Input 1	32: Intermediate position 2	As intermediate position 1 but with higher priority than intermediate positions 3 and 4.
			33: Intermediate position 3	As intermediate position 1 but with higher priority than intermediate position 4.
			34: Intermediate position 4	As intermediate position 1 but with lowest priority.
			35: Emergency position	Approach emergency position (P 8.5). As intermediate position 1 but with higher priority than intermediate positions 1, 2.
			36: Intermediate position 1 inv.	As Intermediate position 1 but active low.
			37: Intermediate position 2 inv.	As Intermediate position 2 but active low.
			38: Intermediate position 3 inv.	As Intermediate position 3 but active low.
			39: Intermediate position 4 inv.	As Intermediate position 4 but active low.
			40: Emergency position inv.	As Emergency position but active low.
			41: Travel Open	Reserved for future use.
			42: Travel Close	Reserved for future use.
			43: Travel Open inv.	Reserved for future use.
			44: Travel Close inv.	Reserved for future use.
			45: Failsafe lock	Reserved for future use (only for Failsafe actuators)
46: Failsafe lock inv.	Reserved for future use (only for Failsafe actuators)			
P9.2	Binary Input	Input 2	See Input 1	
P9.3	Binary Input	Input 3	See Input 1	
P9.4	Binary Input	Input 4	See Input 1	
P9.5	Binary Input	Input 5	See Input 1	

8.9 Parameter Group: Binary Outputs

The controller is equipped with 8 freely configurable binary outputs. Please find further information on technical data of the binary outputs in [Section 28.1](#). Provided with external supply, binary outputs are optically isolated from the rest of the controller.

Default binary outputs are as follows:

Output 1: Ready

Output 2: End position OPEN

Output 3: End position CLOSED

Output 4: Run OPEN

Output 5: Run CLOSED

Output 6: Torque

Output 7: LOCAL

Output 8: REMOTE

Table 16. Binary Outputs Table (1)

	Menu Item	Sub Menu Item	Position Setting	Notes/Comments
P10.1	Binary Output	Output 1	0: User Defined	Optional
			1: Ready	Actuator is ready
			2: Fault	General fault; actuator is not ready
			3: Open	Actuator is in open position
			4: Closed	Actuator is in closed position
			5: Running Open	Actuators runs in direction Closed
			6: Running Closed	Actuators runs in direction Closed
			7: Running	Actuator is running in either Open or Closed
			8: Torque Open	Switch off torque was reached in Open direction-actuator has been switched off
			9: Torque Closed	Switch off torque was reached in Closed direction-actuator has been switched off
			10: Torque	Switch off torque was reached in either Closed or Open direction
			11: Travel Open	The Open end position has been reached
			12: Travel Closed	The Closed end position has been reached
			13: Position > Int.1	Position > Intermediate position 1
			14: Position < Int.1	Position < Intermediate position 1
15: Position > Int.2	Position > Intermediate position 2			

Table 17. Binary Outputs Table (2)

	Menu Item	Sub Menu Item	Position Setting	Notes/Comments
P10.1	Binary Output	Output 1	16: Position < Int.2	Position < Intermediate position 2
			17: Position < Int.3	Position > Intermediate position 3
			18: Position < Int.3	Position < Intermediate position 3
			19: Position < Int.4	Position > Intermediate position 4
			20: Position < Int.4	Position < Intermediate position 4
			21: Local	Local operating mode (selector switch in position)
			22: Remote	Remote operating mode (selector switch in position Remote)
			23: Off	Off operating mode (selector switch in the Off position)
			24: No Function	No function
			25: Motor Error	The motor temperature sensor has reported an error
			26: Always	Signal is always on
			27: Never	Signal is always off
			28: Binary Input 1	Forwarding of binary input to output
			29: Binary Input 2	Forwarding of binary input to output
			30: Binary Input 3	Forwarding of binary input to output
			31: Binary Input 4	Forwarding of binary input to output
			32: Binary Input 5	Forwarding of binary input to output
			33: Torque Open ma.	As Torque OPEN although it will suppress (mask) this signal in the end position upon torque-dependent switch off.
			34: Torque Closed ma.	As Torque CLOSED although it will suppress (mask) this signal in the end position upon torque-dependent switch off.
			35: Ready Remote	Ready and Remote operating mode
36: Ready Local	Ready and Local operating mode			
37: Ready Local/Remote	Ready and Local or Remote mode			
38: Lock Open	Lock OPEN is enabled. OPEN command is internally queued with the highest priority and will not be dropped even in the end position.			
39: Lock Closed	Lock CLOSED is enabled. CLOSED command is internally queued with the highest priority and will not be dropped even in the end position.			

Table 18. Binary Outputs Table (3)

	Menu Item	Sub Menu Item	Position Setting	Notes/Comments
P10.1	Binary Output	Output 1	40: Fail-safe OK 1	Fail-safe OK (only for fail-safe actuators)
			41: Fail-safe OK 2	Fail-safe OK and Ready (only for fail-safe actuators)
			42: Fail-safe OK 3	Fail-safe OK, Ready and Remote (only for fail-safe actuators)
			43: Lock	Lock Open or Lock Closed is enabled.
			44: Ready/Torque OK	Actuator is ready and no torque switch off.
			45: Ready/Remote/Torque OK	Actuator is ready for operation in REMOTE mode and no torque switch off.
			46: Position=Int1	Position = Intermediate position 1. The width of the interval is set with the parameter P8.6.
			47: Position=Int2	Position = Intermediate position 2. The width of the interval is set with the parameter P8.6.
			48: Position=Int3	Position = Intermediate position 3. The width of the interval is set with the parameter P8.6.
			49: Position=Int4	Position = Intermediate position 4. The width of the interval is set with the parameter P8.6.
			50: Position = Emergency Position	Position = emergency position. The width of the interval is set with the parameter P8.6.
			51: Bus Bit 1	In existing bus interface (hardware option) the output is set according to the selected bit bus.
			52: Bus Bit 2	
			53: Bus Bit 3	
			54: Bus Bit 4	
			55: Bus Bit 5	
			56: Bus Bit 6	
			57: Bus Bit 7	
			58: Bus Bit 8	
			59: Virtual 1	Configurable output function.
			60: Virtual 2	
			61: Virtual 3	
			62: Virtual 4	
63: Line voltage OK	Supply voltage for the motor is OK.			
64: Control voltage OK	The auxiliary voltage for the SMARTCON control is OK. This function is only available if the auxiliary voltage output is not switched on (P6.5 to 0).			
65: Oil pressure OK	The oil pressure is higher than the minimum pressure (P6.10)			
66: Oil level OK	The oil level is OK.			
67: Pump OK	The temperature sensor in the pump motor and the external motor protection have not tripped.			

Table 19. Binary Outputs Table (4)

	Menu Item	Sub Menu Item	Position Setting	Notes/Comments
4-5 P10.2	Binary Output	Output Configuration 1	Normal	Output 1 is set to normal, i.e., if the condition in point P10.1 is met, Output 1 is set to HIGH (active HIGH).
			Inverted	If the condition in point P10.1 is met, Output 1 is set to LOW (active LOW).
			Normal Flashing	If the condition in point P10.1 is met, Output 1 starts blinking (active HIGH).
			Inv. Flashing	If the condition in point P10.1 is not met, Output 1 starts blinking (otherwise it is set to HIGH).
P10.3	Binary Output	Output 2	See Output 1	
P10.4	Binary Output	Output 2 Configuration	See Output 1 Configuration	
P10.5	Binary Output	Output 3	See Output 1	
P10.6	Binary Output	Output 3 Configuration	See Output 1 Configuration	
P10.7	Binary Output	Output 4	See Output 1	
P10.8	Binary Output	Output Configuration 4	See Output 1 Configuration	
P10.9	Binary Output	Output 5	See Output 1	
P10.10	Binary Output	Output Configuration 5	See Output 1 Configuration	
P10.11	Binary Output	Output 6	See Output 1	
P10.12	Binary Output	Output Configuration 6	See Output 1 Configuration	
P10.13	Binary Output	Output 7	See Output 1	
P10.14	Binary Output	Output Configuration 7	See Output 1 Configuration	
P10.15	Binary Output	Output 8	See Output 1	
P10.16	Binary Output	Output Configuration 8	See Output 1 Configuration	

CAUTION: OBSERVE IF END POSITION IS REACHED

When using the point torque-dependent OPEN or torque-dependent CLOSED (see [Section 18.1](#), Menu P1.3 and P1.4) the actuator will only be open or closed when the set torque and the associated end position is reached. If the end position is not reached, a torque error is reported (see [Section 17.2.2](#)).

8.10 Parameter Group: Position Output (optional)

Position output is used to indicate the current position of the actuator using 0/4-20 mA; it can be retrofitted using software code. If this option is not enabled, the menu point shows the message "inactive". No adjustment to the end positions or the travel is required. Adjustment is automatically performed during the configuration of travel limit positions (see Section 18.1). No further settings are necessary for torque-dependent switch off, because the controller exclusively uses travel limit positions for the calculation. Regardless of whether this is defined by the torque or the travel limit positions.

The factory default settings are:

- 4mA at 0% position
- 20mA at 100% position

Table 20. Position Output Table

	Menu Item	Sub Menu Item	Position Setting	Notes/Comments
P11.1	Position Output	Function 1	0: off	mA output disabled.
			1: Position	mA output corresponds to the actual position value.
			2: Pos. Valvechar.	mA output corresponds to the actual position value taking into account the valve characteristic.
			3: Torque 1	mA output corresponds to the actual torque value.
			4: Torque 2	mA output corresponds to the actual torque value.
				Torque = 100% Close: mA output = end
				Torque = 0%: mA output = start
			5: Torque 3	Torque = 100% Open: mA output = end
				mA output corresponds to the actual torque value.
				Torque = 150% Close: mA output = start
			6: Torque 4	Torque = 0%: mA output = center
				Torque = 150% Open: mA output = end
				mA output corresponds to the actual torque value.
Torque = 150% Close: mA output = end				
P11.2	Position Output	Start (at 0%)	0 - 20.5 mA [4 mA]	mA value for the Closed (0%) position
P11.3	Position Output	End (at 100%)	0 - 20.5 mA [20 mA]	mA-value for the On (100%) position
P11.4	Position Output	Calibration 20mA	-10% - +10%	Calibrating the output position during the setting of this parameter will output a 20mA (100%) signal. Use this parameter to calibrate accurately the 20mA output signal. (e.g., if you measure 19.8mA at the output, just add 1% (0.2mA - 1% of 20mA) to the displayed value.
P11.5	Analog Output	Function 2	see Function 1	
P11.6	Analog Output	Start 2 (at 0%)	see Start	
P11.7	Analog Output	End 2 (at 100%)	see End	
P11.8	Analog Output	Calib. 20mA 2	see Calib. 20 mA 1	

8.11 Parameter Group: Step Mode

Step mode operation can be used to extend the operating time in certain ranges or for the whole travel; it is available in local, remote and emergency mode. Step mode operation can be activated individually for the directions OPEN and CLOSED. Cycle start, cycle end, cycle duration and interval time can be set separately for both directions. (see [Figure 62](#)).

Table 21. Step Mode Table

	Menu Item	Sub Menu Item	Position Setting	Notes/Comments
P12.1	Step Mode Function	Mode	Disabled	Step mode operation is disabled.
			Enabled	Step mode operation is enabled in LOCAL, REMOTE and EMERGENCY operation.
			Local only	Step mode mode is only enabled in LOCAL mode.
			Remote only	Step mode mode is only enabled in REMOTE mode.
			Local + Remote only	Step mode is enabled in REMOTE and LOCAL mode.
P12.2	Step Mode Function	Start Open	0 - 100%	In OPEN direction, position in % from which the step mode operation should start.
P12.3	Step Mode Function	End Open	0 - 100%	In OPEN direction, position in % of which the step mode operation should end.
P12.4	Step Mode Function	Runtime Open	0.1 - 60	Runtime in OPEN direction.
P12.5	Step Mode Function	Pause Time Open	0.2 - 60	Pause time in OPEN direction.
P12.6	Step Mode Function	Start Closed	0 - 100%	In CLOSED direction, position in % from which the step mode operation should start.
P12.7	Step Mode Function	End Closed	0 - 100%	In CLOSED direction, position in % of which the step mode operation should end.
P12.8	Step Mode Function	Runtime Closed	0.1 - 60	Runtime in Closed direction.
P12.9	Step Mode Function	Pause Time	0.2 - 60	Pause time in Closed direction.
P12.10	Step Mode Function	Timebase	0: Seconds	Time basis for run and pause times.
			1: Minutes	
P12.11	Step mode function	Speed adaption	0:	Speed adaption not activated. Normal step mode function.
			1:	Speed adaption is activated. The speed is reduced according to the runtime and pause time in the step mode range. (Example: Running time 1 sec and pause time 1 sec results in half the speed). If the minimum speed is undershot, the actuator clocks in the converted ratio with the minimum speed. The speed adjustment is only applicable to actuators of the type CM and AB CSC.

Figure 58 Step Mode Operation

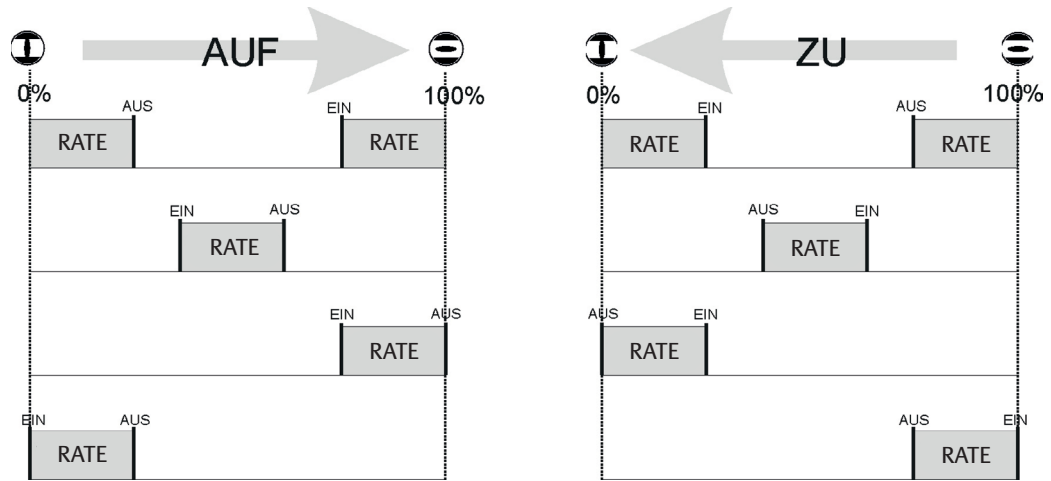

NOTE:

It is important to ensure that the mode of operation is not exceeded. The running info on the actuator (see Section 7.2) only flashes while the drive is running, i.e., during the break, no flash.

8.12 Parameter Group: Positioner (option)

The positioner SR option is used to control the electric actuator by means of a set point input 0/4-20 mA signal. The SR helps control the position of the actuator, i.e., the positioner ensures that the actual value and thus the position of the actuator matches the desired set point.

Table 22. Positioner Table (1)

	Menu Item	Sub Menu Item	Position Setting	Notes/Comments
P13.1	Positioner	Function	Off	Positioner disabled.
			1: Position	mA input for the position setpoint.
			2: Pos. valvechar.	mA input for the position setpoint, taking into account the valve characteristic.
P13.2	Positioner	Begin (at 0%)	0 – 20.5 mA {4, 0 mA}	mA value of the setpoint for the CLOSED (0%) position.
P13.3	Positioner	End (at 100%)	0 – 20.5 mA {20, 0 mA}	mA value of the setpoint for the OPEN (100%) position.
P13.4	Positioner	Dead band	0,1 – 10,0% {1,0%}	Tolerance range for the control deviation (set point position - actual position) where no adjustment occurs. The deadband should not be set too low to prevent actuator oscillation.
P13.5	Positioner	Gain	1 – 100% {100%}	The gain (gradient) affects the positioning close to the target position. The smaller the gain selected (for example, 20%), the earlier the actuator starts reducing its speed in case of speed variable actuators on approaching the target position. In case of actuators with fixed speed (reversing starters) the speed reduction is done by pulsing (also see parameters P13.9 and P13.10). This provides a better positioning (smaller reachable deadband). A 100% setting disables this gradient.

Table 23. Positioner Table (2)

	Menu Item	Sub Menu Item	Position Setting	Notes/Comments
P13.6	Positioner	Live zero detect	Ignore	The setpoint monitoring (monitoring the setpoint to below approximately 2mA = loss of signal) is disabled.
			Stop	Actuator stops on signal failure.
			Open	Actuator moves to OPEN position.
			Close	Actuator moves to CLOSED position on signal failure.
			Emergency Position	On signal failure, the actuator moves to defined emergency position (see parameter P13.7).
			Emergency PID	Reserved for future use.
P13.7	Positioner	Emergency position	0 – 100% {50.%}	Determination of the emergency position. (It can also be set in the menu P8.5)

P13.8	Positioner	Calibration setpoint	-10% - +10%	Calibration value for the mA setpoint. Calibration process: By applying 20mA on the setpoint input, this parameter is corrected until the readout matches 20mA.
P13.9	Positioner	Minimum Impulse	{0.2 s}	Minimum activation time of the reversing contactors. For very small activation times (<0.3 to 0.5s), the motor will be switched off during start-up process, which increases significantly reversing contactors mechanical wear. With frequent periods of very small activation times (restless loop, small dead zone, clocking near to the target value), we therefore recommend electronic reversing contactor.
P13.10	Positioner	Period	{2.0 s}	This parameter is only relevant when step mode is enabled and when approaching the target position (parameter gain smaller than 100 %) and determines the period of a run/pause cycle.
P13.11	Positioner	Begin position (a0)	0.0 – 25.0% {2.0%}	Smallest controllable position other than the end position CLOSED. The range 0% to a0 will be just passed through. Use the parameter a0 to define the beginning of the allowable control range of the valve (e.g., blind spot for ball segment valves, etc.).
P13.12	Positioner	End Position (e0)	75.0 – 100.0% {98.0%}	Largest controllable position other than the end position OPEN. The area e0 to 100% is just passed through. Use the parameter e0 to define the end of the allowable control range of the valve.
P13.13	Positioner	Begin Setpoint (a1)	0.0 – 25.0% {2.0%}	Below this value, the end position CLOSED is controlled. In the range 0% to a1 cannot be controlled (end position tolerance). The initial setpoint a1 is associated with a small hysteresis (1/4 of the deadband).
P13.14	Positioner	End Setpoint (e1)	75.0 – 100.0% {98.0%}	Above this value, the end position OPEN is controlled. The range e1 to 100% cannot be controlled (end position tolerance). The final setpoint e1 is associated with a small hysteresis (1/4 of the deadband).
P13.15	Positioner	Calib. setpoint offset	-10% - +10%	Calibration of zero for the input setpoint. 1% = 0.2 mA.

Figure 59 Assigning the Position to the Setpoint

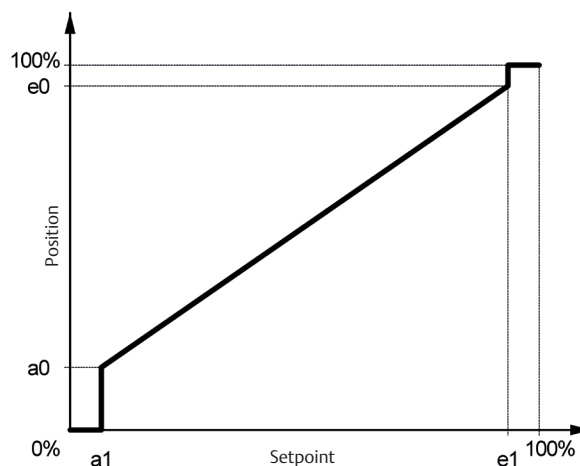

8.13 Parameter Group: PID Controller (optional)

The optional PID controller is used for controlling an external actual value (process variable) to a setpoint using 0/4-20 mA signal by readjusting the actuator.

Table 24. PID Controller Table (1)

	Menu Item	Sub Menu Item	Position Setting	Notes/Comments
P14.1	PID controller	Function	0: disabled	PID controller disabled.
			1: Position	The output of the PID controller corresponds to the position setpoint of the actuator. The positioning (tracking of the actual position to the setpoint) is done by the positioner (see Section 18.12).
			2: Speed	The output of the PID controller corresponds to the speed of the actuator (speed mode is only possible for Actusmart CM and Smartcon CSC FU!). There is no adjustment with the positioner. ³⁾
			3: Speed	The output of the PID controller corresponds to the change of the position setpoint (speed) of the actuator. The positioning (tracking of the actual position to the setpoint) is done by the positioner (see section 7.12). Hence a control mode similar to the Speed mode (see Setting 2, above) is possible also for actuators with constant speed. ⁶⁾

Table 25. PID Controller Table (2)

	Menu Item	Sub Menu Item	Position Setting	Notes/Comments
P14.2	PID controller	External Setpoint	0: Fixed	The PID controller uses an internal, fixed setpoint (see parameter P14.3).
			1: External	The PID controller uses the external setpoint. The adjustment of this setpoint is done with the parameters P13.2 and P13.3 (see Section 18.12).
P14.3	PID controller	Fixed setpoint	0 – 100%	Specification of the internal fixed setpoint.
P14.4	PID controller	Start (at 0%)	0 - 20.5 mA	mA value at 0% of the external actual value.
P14.5	PID controller	End (at100%)	0 - 20.5 mA	mA value at 100% of the external actual value.
P14.6	PID controller	Gain (P)	+50.0 - 50.0	Gain (proportional value) of the PID-controller. A negative value reverses the effective direction of the PID-controller, e.g.: Positive gain: The actuator opens when the desired value is greater than the external actual value. Negative gain: The actuator closes when the desired value is greater than the external actual value.
P14.7	PID controller	Reset time (I)	0 – 100.0s	The shorter the reset time (integral time, integral value), the stronger is the effect of the integral component of the PID-controller. Values below 1,0 will disable the integral component.
P14.8	PID controller	Lead Time (D)	0 – 100.0s	The larger the lead time (differential/derivative value), the stronger is the effect of the derivative component of the PID-controller. To reduce the influence of noise a first-order lag element with 1sec. time constant is added (DT ₁).
P14.9	PID controller	Offset	-200 – 200%	The offset value will be added to the output value of the PID controller.
P14.12	PID controller	Live zero detect.	Ignore	The monitoring of the external actual value is disabled.
			Stop	Actuator stops on signal failure of external. Actual value.
			Open	On signal failure of external actual values, actuator moves to the OPEN position.
			Closed	On signal failure of external actual values, actuator moves to the CLOSED position.
			Emergency position	On signal failure of external actual values, actuator moves to the EMERGENCY position (see param P13.7).
			Emergency PID	Reserved for future use.
P14.13	PID controller	Calibration of External Actual Value	-10.0 – 10.0%	Calibration process: By applying 20 mA to the external actual value input, this parameter is corrected until the readout matches to 20 mA.
P14.14	PID controller	Process start	32768 - 32767	Mantissa of the real process variable (beginning of external actual value)
P14.15	PID controller	PID controller	32768 - 32767	Mantissa of the real process variable (end of external actual value)
P14.16	PID controller	Process comma shift	-3 - 3	Position of the comma for process begin/end (P14.14, P14.15), e.g.: mantissa = 200, comma shift = -2/2, process value = 2.00/20000
P14.17	PID controller	Process unit	--	Unit of the real process variable.
P14.18	PID controller	Dead band	0.1 - 10.0% [1.0%]	Tolerance range for the control deviation (set point – external actual value) where no adjustment occurs. ⁷⁾

8.14 Parameter Group: Characteristic Curves (optional)

With this option, customers can enable travel-dependent torque characteristic curves.

With these characteristic curves, torque limits already set under menu item P2 (torque) can be further reduced depending on travel. Characteristics can be configured with the bluetooth application interface (see Figure 60).

Figure 60 Torque Characteristic Curve

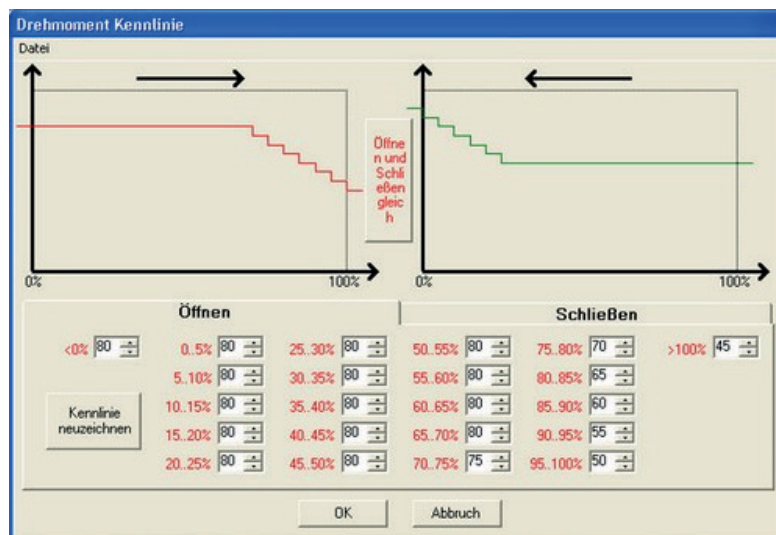

Table 26. Characteristic Table

	Menu Item	Sub Menu Item	Position Setting	Notes/Comments
P17.1	Characteristic	Torque Open	Off	The torque characteristic curve is disabled for the OPEN direction.
			On	The torque characteristic curve is enabled for the OPEN direction.
			Local + Remote only	The torque characteristic curve is enabled for the OPEN direction only in LOCAL and REMOTE mode (while disabled in the EMERGENCY mode).
P17.2	Characteristic	Torque Closed	Off	The torque characteristic curve is disabled for the CLOSED direction.
			On	The torque characteristic curve is enabled for the CLOSED direction.
			Local + Remote only	The torque characteristic curve is enabled for the CLOSED direction only in LOCAL and REMOTE mode (while disabled in the EMERGENCY mode).

8.15 Parameter Group: Identification (option)

This option allows entering further custom-identification parameters.

Table 27. Identification Table

	Menu Item	Sub Menu Item	Position Setting	Notes/Comments
P18.1	Identification	PPS number	15-digit	Used to enter a PPS number. This is displayed in the bottom line. CAUTION: point P20.5 must be set to 0.

8.16 Parameter Group: System Parameters (locked)

Used for actuator configuration and not available for customers.

8.17 Parameter Group: Miscellaneous

Table 28. Miscellaneous Table (1)

	Menu Item	Sub Menu Item	Position Setting	Notes/Comments
P20.1	Miscellaneous	Language	0: German	Defines the menu language
			1: English	
			2: Russian	
			3: Czech	
			4: Spanish	
			5: French	
			6: Italian	
			7: Danish	
			8: Hungarian	
			9: Turkish	
			10: Greek	
			11: Polish	
			12: Serbian	
13: Croatian				
P20.2	Miscellaneous	Smartcode		Enables additional features by entering a Smartcode
P20.3	Miscellaneous	Load Configuration	Customer Configuration -	By saving this setting, all parameters except the end positions are reset to the customer parameters.
			Customer Configuration +	By saving this setting, all parameters are reset to the customer parameters.
			Backup Parameters -	By saving this setting, all parameters except the end positions are reset to the factory settings.
			Backup Parameters +	By saving this setting, all parameters are reset to the factory settings.
P20.4	Miscellaneous	Backup Parameters	Customer Configuration	By saving this setting, the currently set parameters are adopted as customer parameters.
P20.5	Miscellaneous	Info line	{0} - 31	The fourth line of the display shows various diagnostic values.

Table 29. Miscellaneous Table (2)

	Menu Item	Sub Menu Item	Position Setting	Notes/Comments
P20.6	Miscellaneous	Infrared	Off	The infrared connection is disabled.
			1: Infrared	The infrared connection is activated for about 3 minutes.
			2: Bluetooth	The Bluetooth connection is active for about 3 minutes unless communication is detected.
			3: Infrared +	The infrared connection is activated.
			4: Bluetooth +	The Bluetooth connection is activated.
P20.7	Miscellaneous	Menu style	0 - 2	Different menu styles.
P20.11	Miscellaneous	Daylight saving time	Off	Normal time is activated.
			On	Daylight saving time is activated.
			Auto	The actuator switches automatically between Daylight saving time and Normal time.

Section 9: Status Area

The status area presents current process and diagnostic data. Here data is read-only. To access the status area, move the control switch in the direction where the selector switch should be in the neutral position or in the remote position.

The status area is divided into 2 sub-areas:

- Status
- History

9.1 Status

9.1.1 Status - Binary Outputs

Display of binary outputs: The display shows output control as opposed to output status, i.e., the supply of the binary outputs is ignored. A switched output is represented by 1.

Figure 61 Binary Outputs Display

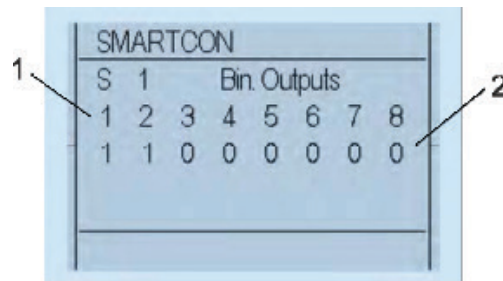

Display Overview:

4. Output Number
5. Signal (0=LOW; 1=HIGH)

9.1.1 Status - Binary Inputs

Display of binary inputs: A set input is represented by 1.

Figure 62 Binary Inputs Display

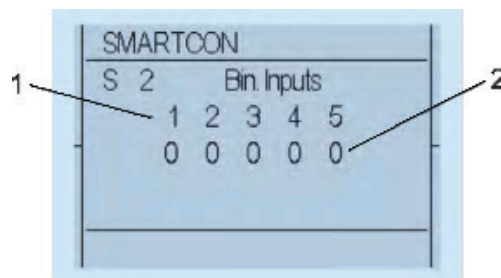

Display Overview:

1. Input Number
2. Signal (0=LOW: 1=HIGH)

9.1.1 Status - Analog Values

Display of analog values: Input 1 (In1) is used by the positioner as the setpoint; Input 2 (In2) serves as an external value for the optional PID controller. In the analogue output (out), only the control signal is shown, regardless of whether the output current actually flows or not (interruption of the current loop).

Figure 63 Analog Values Display

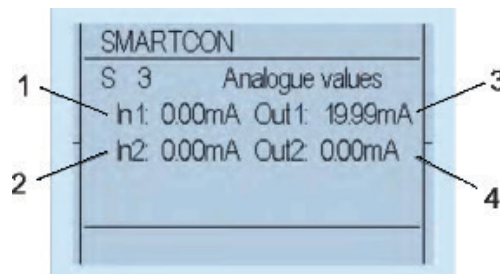

Display Overview:

1. Input 1
2. Input 2
3. Output
4. All values in mA

9.1.1 Status - Absolute Values

This status displays the absolute position of the actuator.

Figure 64 Absolute Value Display

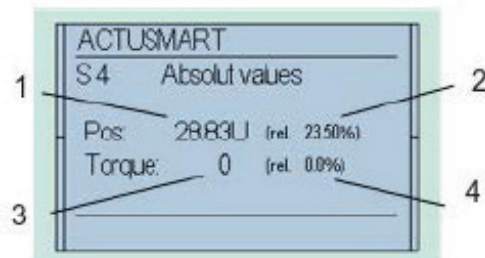

Display Overview:

1. Absolute value of the position unitSerial Number of the Actuator
2. Relative value of the position unit 3 and
3. Absolute and relative value for the torque unit (calibrated in factory)

9.1.3 Status - Firmware

Figure 65 Firmware Display

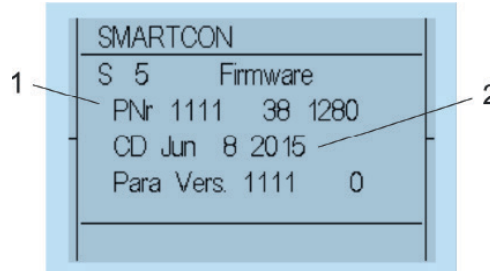

Display Overview:

1. Firmware
2. Firmware Date

9.1.4 Status - Serial Number

Figure 66 Serial Number Display



Display Overview:

1. Serial Number of the Control Unit
2. Serial Number of the Actuator
3. Serial Number of Electronics

9.1.1 Status - Meter Readings

Figure 67 Meter Readings Display

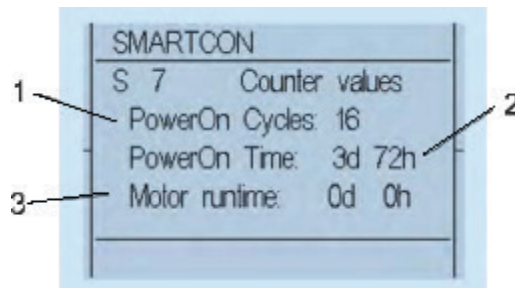

Display Overview:

1. Power-On Cycles
2. Operating Hours
3. Engine Duration

9.2 History

History shows the last 20 history entries. In addition to the plain text entry, the time since the last history entry is also provided. Please note that the actuator can only calculate time if energized. For error analysis, please refer to Section 13.1.

Section 10: Infrared Connection

For easier communication and better visualization of the menu options, the unit provides an infrared port for connection to a PC.

The required hardware (connection cable to the PC's RS-232 or USB connectors) and the corresponding software are available as options.

The SMARTTOOL software, in addition to communication with the actuator, allows the management of multiple actuators to transfer the configuration to different actuators.

This approach can greatly simplify operation.

Please refer to the SMARTTOOL software operating instructions manual for further information.

During operation, ensure that the IR interface surface is protected from strong disturbances which may compromise the communication.

Before mounting the infrared adapter, clean the surface of the infrared interface with a damp cloth.

When the infrared interface is enabled, it is indicated by Light-emitting (LED) (see Figure 68).The infrared interface can be enabled in the menu item P20.6.

Figure 68 LED IR Indicator

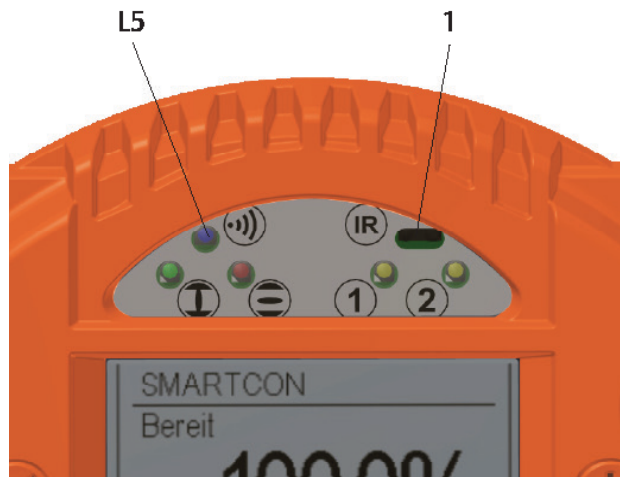

Section 11: Bluetooth Link

In addition to the infrared interface, it is also possible to configure the Control System using a Bluetooth interface. Software required for Android equipment is available as an option.

In addition to communication with the actuator, the Android software also enables management of multiple actuators, allowing easy transfer of parameter sets to various actuators.

This approach can simplify commissioning significantly.

When the Bluetooth interface is enabled, this is indicated by the light-emitting diode L5 (see Figure 68). The Bluetooth interface can be enabled in menu item P20.6.

Section 12: Maintenance

All maintenance work may only be performed with the actuator powered-off. Due to this requirement, the actuator has to be in the fail-safe position. If this is not the case, it may be because of a fault in the fitting (stuck fitting shaft).

CAUTION: OBSERVE SAFETY MEASURES

The actuator has a preloaded disk spring assembly. When loosen the flange mounting bolts, the spring force against the valve can cause the actuator to come loose from the valve. Adequate safety measures must be taken.

Any powering up must be ruled out during maintenance. Work on the electrical systems or components may only be carried out by electricians or by individuals who have been instructed how to do so. Working under the guidance and supervision of an electrician in accordance with electrotechnical regulations. After completing their commissioning, the actuators are ready for use. The actuator is filled with oil as standard when shipped.

Routine checks:

- Be mindful of increased running noises. In cases of long downtimes, operate the actuator at least every three months.
- Check the fail-safe function (check the operating time and smoothness of running in fail-safe operation). Lengthening in the running time may also be caused by an increased torque requirement for the fitting after long down times.

CAUTION: ALWAYS REFER TO INSTRUCTIONS

The actuator has a prestressed disk spring assembly. Improper dismantling may lead to both damage to the actuator as well as serious injuries. If maintenance work is needed requiring the actuator to be dismantled, contact Emerson regarding detailed instructions and/or any special purpose tools for relaxing the spring assembly.

The actuators are designed for any mounting position (see Section 3.5), which is why there is neither a filling level indicator nor a drain plug on the main casing.

Depending on the stressing subjected to, do the following approximately every 10,000 to 20,000 hours (about 5 years; see Section 15):

- Oil change
- Replace seals
- Check all the roller bearings and the worm gear assembly and replace if necessary.

Take the types of oils and greases to be used from our Lubricant Table (see Section 15).

Section 13: Troubleshooting

Upon warning or error, the bottom line of the display will show the corresponding plain text description. This event will also be entered into the history (see [Section 18.2](#)).

13.1 Error List

Table 30. Error List (1)

Error	LED Indicators	Description
#3: Mot. temp. warn. #19: Mot. temp. warn. OK	L4 flashes	The motor temperature is in the critical range although the actuator remains fully functional.
#4: Mot. temp. trip. #20: Mot. temp. OK.	L4 is off	Overtemp in motor, fault on Basis or BLDC, On Basis: loss of main power (3x400V) or cable break between CSC and motor; on BLDC: cable break between BLDC and motor.
#5: Phase sequ. error #6: Phase sequ. OK	L4 is off	Cause on Basis: Active phase sequence detection on single phase actuators, loss of main power while connected to external 24VDC auxiliary voltage, or loss of phase L2.
#7: Ready	L4 is off	Written to the history after all errors are gone.
#8: Power On	L4 is off	Is written to the history after power on the actuator, even if there are some errors.
#9: Power supply error #21: Power supply OK	L4 is off	No power supply to the power electronics (when the controller is powered from the auxiliary power input). Defect of power electronics – please contact the manufacturer.
#11: Failsafe error #12: Failsafe OK	L4 is off	Communication error between Failsafe board and Logic, loss of external 24 V Failsafe Voltage, or overtemp. on Failsafe brake.
#13: Manual override #14: Manual override off	L4 is off	Manual override on Failsafe activate (visible in status S4), cable/switch broken.
#17: Travel error #18: Travel OK	L1 and L2 lit up L4 flashes fast	The travel unit is outside the permitted range (potentiometer fault on Basis), cable broken, or multiturnsensor calibration lost on CM – please contact the manufacturer.
#22: Torque error #23: Torque OK	L3 flashes fast L4 is off	Potentiometer fault on Basis, or cable broken.
#24: Bus error #25: Bus OK	L4 flashes slowly	No communication with the optional bus system.
#26: Bus Watchdog #27: Bus Watchdog OK	L4 flashes slowly	Watchdog for bus communication has reacted.
#28: Undervoltage #29: Voltage OK	L4 is off	reserved for future use
#32: Internal Comm.L> error #33 Internal Comm. L> OK	L4 is off	Communication error between Logik and Basis/BLDC, cable broken between boards, or board defect.
#34: Internal Comm.D> error #35: Internal Comm. D> OK	L4 is off	Communication error between Display and Logik, cable broken between boards, boards defect, or firmware update on Logik not properly done.

Table 31. Error List (2)

Error	LED Indicators	Description
#36: Failsafe not ready #37: Failsafe ready	L4 flashes slowly	Failsafe voltage OK and Failsafe not initialized (LUS not tensioned).
#38: Battery low #39: Battery OK	L4 is off	Battery on Display board is empty, loss of time/date or counter values possible.
#44: Inverter error Para #45: Inverter OK Para	L4 is off	BLDC parameter error.
#46: Analog Input 1 Failure #47: Analog Input 1 OK	L4 flashes slowly	SRG active, Positioner live zero detection activated, no setpoint value recognized.
#48: Analog Input 2 Failure #49: Analog Input 2 OK	L4 flashes slowly	Ext. setpoint active, Ext. setpoint live zero detection activated, no Ext. setpoint value recognized
#30: Oil level low #31: Oil level OK	–	Binary input on Basis board or switch faulty.
#40: Oil pressure low #41: Oil pressure OK	–	Analog input (4...20 mA) on Basis board faulty.
#42: Motor protection #43: Motor protection OK	–	Binary input on Basis board or switch faulty.

Section 14: Fuses

The logic board of the controller cover (see Figure 69) features two miniature fuses for the control lines.

Figure 69 Logic Board Controller



Parts Overview:

1. Fuse F10a for the Binary Outputs
2. Fuse F10b for auxillary

Table 33. Fuses on the Logic Board

Fuse	Value	Manufacturer	List of Spare Parts
F10a	1AT	Littelfuse 454 NANO ² Slo-Blo [®] träge	C302c
F10b	4AT	Littelfuse 454 NANO ² Slo-Blo [®] träge	C302d

The frequency inverter is protected by an input fuse and the explosionproof version also has a thermal fuse (see [Section 12.7.3](#)).

Section 15: Lubricant Recommendations and Requirements

15.1 Main Body: -25°C to +60°C

Operating Oil: DIN 51 517-CLP-HC

i.e. fully synthetic high-performance gear oils based on poly-alpha-olefins (PAO):

Viscosity class:	320 ISO VG
Pourpoint:	< -39C (according DIN ISO 3016)
Lubricant requirement CM03:	200 - 250 ml
Lubricant requirement CM06:	400 - 450 ml

15.2 Main Body: -40°C to +60°C

Operating oil: DIN 51 517-CLP-HC

i.e. fully synthetic high-performance gear oils based on poly-alpha-olefins (PAO):

Viscosity class:	68 ISO VG
Pourpoint:	< -54C (according DIN ISO 3016)
Lubricant requirement CM03:	200 - 250 ml
Lubricant requirement CM06:	400 - 450 ml

15.3 Output type A and spindle drives (Linear Actuators) -40 to +60C

Grease DIN 51825-K(P) R -40

i.e. water repellent complex grease on Al-soap base with high resistance to acids and alkalis:

Penetration 0.1 mm:	to 265
Dropping point:	about 260C
NLGI No.:	1

acid-free, little or not water-reactive

15.4 Basic Lubricant Service Interval

CAUTION: CONSIDER REDUCTION FACTORS

The functionality and durability of the lubricant is contingent upon operating conditions. It is advised that the Bettis actuators be serviced by Emerson 10 years after delivery.

Table 34. Lubrication Utilization (1)

Operating Condition(s)	Definition	Reduction Factor (Multiplier)
Duty Time DT	(Total motor running time)	
Extremely High DC	Over 1,250 hours/year	0.5
High DC	Over 500 hours/year	0.7
Extremely Low DC	Less than 0.5 hours/year	0.8
Ambient Temperature	(Permanent or long-term)	
Extremely Changeable	Between -10°C and +50°C	0.5
Extremely High	Over +50°C	0.7
Extremely Low	Below -25°C	0.9
Output Speed	(On actuator main shaft)	
High Speed	Over 80 rpm	0.8
Utilization	(Relative to rated power)	
Very High	Over 90%	0.8
High	Between 80 to 90%	0.9

Example of application:

Extremely low DC + extremely low ambient temperature + high speed + 87% degree of utilization:

$0.8 \times 0.9 \times 0.8 \times 0.9 = 0.51$ Reduction factor

Lubricant maintenance interval: 10 years \times 0.51 = 5.1 years (62 months)

CAUTION: LUBRICATE PROPERLY

This calculated maintenance interval does neither apply to the maintenance of output type A (threated bushing) units nor to the maintenance of linear and spindle drive units. These units must periodically lubricated (at least every 6 months) via the grease nipples (see Section 15.3)

During maintenance of our actuators, remove and replace old grease with new one.

Mixing of different lubricant types is NOT permitted.

Quantities needed for lubricant service are listed in Section 15.

Section 16: Training

CAUTION: CONTACT FOR SUPPORT

If you experience problems during installation or upon adjustments on site, please contact Emerson, Texas at +1 281 477 4100 or to prevent any operational errors or damage to the actuators. Emerson recommends engaging only qualified personnel for installation of RTS CM Compact Series actuators. Upon special request of the client, Emerson can conduct training on the activities listed in this operating manual at the factory of Emerson.

Section 17: Technical Data and Certifications

17.1 Binary Outputs

Figure 70 Control Unit

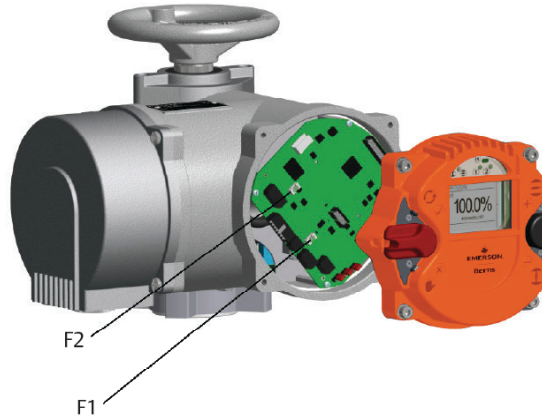

Figure 71 Logic Board

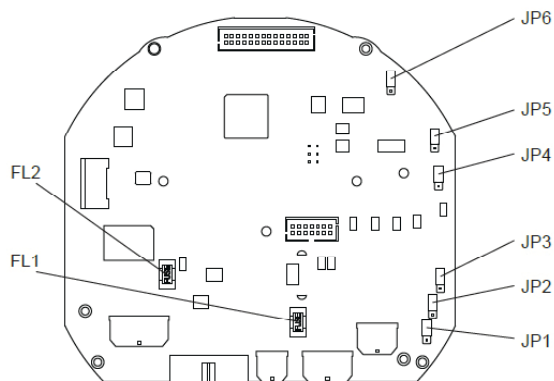

Table 35. Binary Outputs

Characteristic	Value
Count	8
Power supply	24VDC nominal range: 11... 35VDC (either from internal or external)
Max voltage drop at set output	1 V
Output voltage at non-set output	<1 V
Maximum current per output:	500mA (short circuit proof)
Maximum permissible total current for all outputs:	4A
Fuse (Fuse F2, see Figure 68)	4 A slow (Littelfuse 454 NANO2 Slo-Blo®)

Binary outputs with external supply are separated from other controllers via optocouplers.

17.2 Binary Inputs

Table 36. Binary Inputs

Characteristic	Value
Count	5
Nominal voltage	24VDC towards common ground
Threshold voltage for input set	>10 V max. (8.5V typ.)
Threshold voltage for input not set	<10 V
Maximum voltage:	30VDC
Current consumption at 24VDC	10.5mA typ.

Binary inputs are separated from other controllers via optocouplers.

Figure 72 Current/Voltage Relation

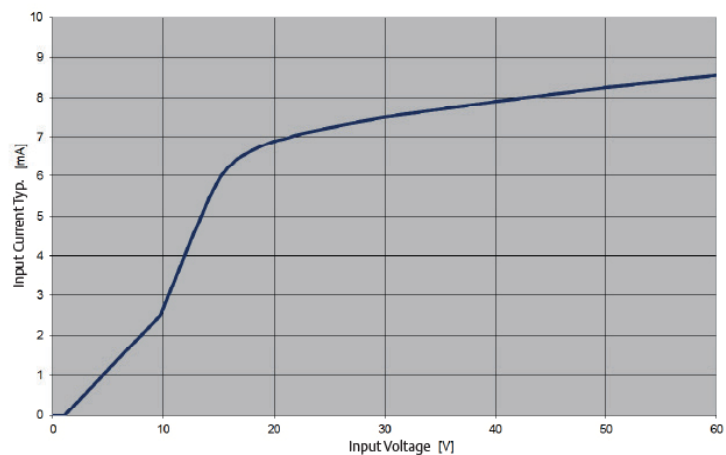

Jumpers JP1 . . . JP3 can be used to interconnect the binary inputs to groups with separate earths.

Figure 73 5 Inputs with Same Common

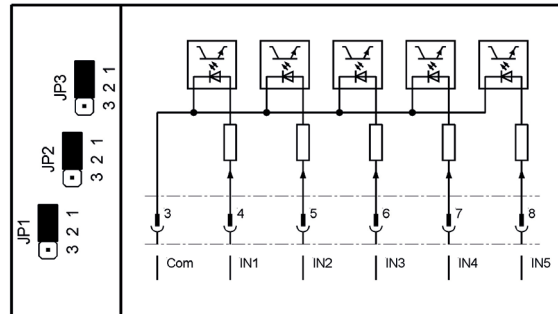

Figure 74 2 Separated Groups of 2 Inputs with Same Ground Input IN3 is Disabled.

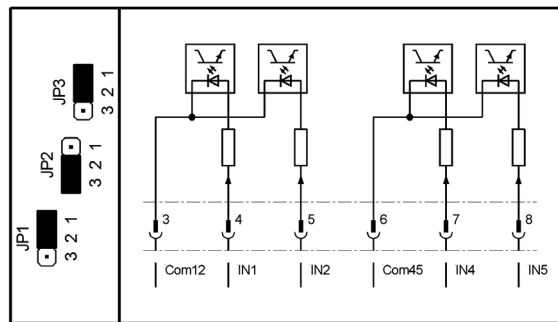

Figure 75 3 Separated Inputs; Inputs IN2 and IN4 are Disabled.

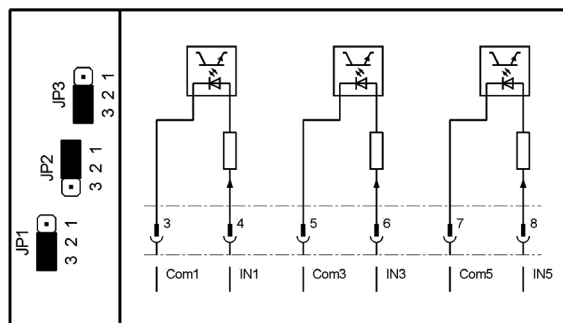

Figure 76 3 Inputs with Same Common and 1 Separated Input. Input IN4 is Disabled.

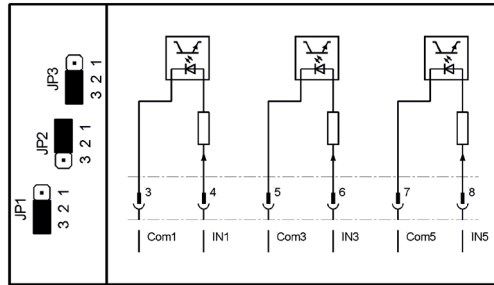

Figure 77 1 Separated Input and 3 Inputs with Same Common. Input IN2 is Disabled.

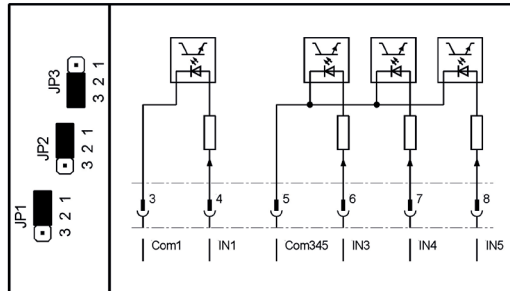

Figure 78 5 inputs with common = "-" using external 24V

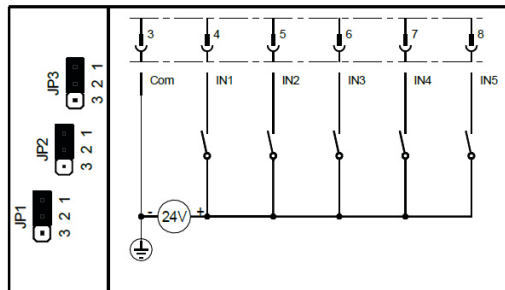

Figure 79 5 inputs with common = "-" using internal 24V (e.g. for dry contacts)

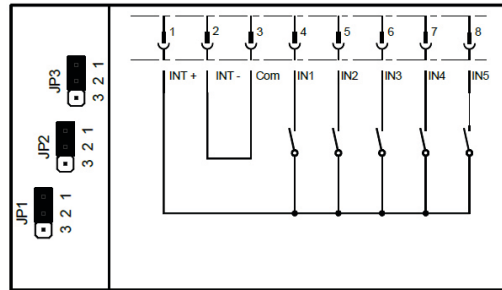

Figure 80 3 separated inputs using 3 separated external 24V

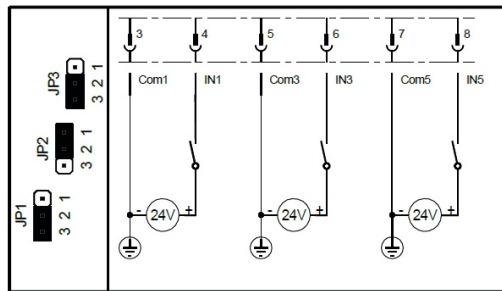
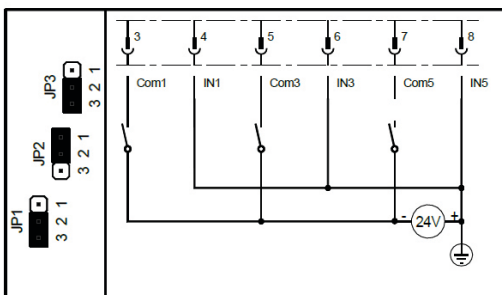

Figure 81 3 separated inputs using 3 separated external 24V



17.3 Analog Inputs

Table 37. Input 1: Setpoint Value

Characteristic	Value
Current range:	0-25mA
Resolution:	14Bit
Accuracy:	0,5%
Input resistance:	60 Ohm

Analog input 1 is electrically isolated from the rest of the electronic system.

**Table 38. Input 2: External Actual Value
Only in Conjunction with the PID Controller**

Characteristic	Value
Current range:	0-20,8mA
Resolution:	10Bit
Accuracy:	0,5%
Input resistance:	120 Ohm

Jumper JP6 can be used to switch analog input 2 from a passive input (default) to an input with internal 24 V power supply (for 4...20 mA, two-wire transmitters).

NOTE:

The analog input 2 is referenced to common of the electronic system and the auxiliary power supply.

17.4 Analog Output

Table 39. Analog Output

Characteristic	Value
Current range:	0-20,8mA
Resolution:	12Bit
Accuracy:	0,5%
Input resistance:	600 Ohm

The analog output is galvanically isolated from the rest of the electronic system.
Jumper JP4 can be used to switch the analog output from an active power source (default) to a current sink, allowing the output to simulate a 4 - 20 mA, two-wire transmitter.

Figure 82 Current Source

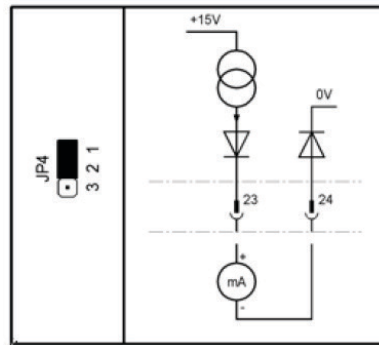
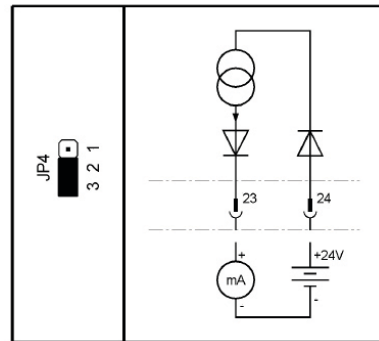

Figure 83 Current Sink



Ground potential is the potential of the control unit and the auxiliary supply (see Chapter 20.5).

17.5 Auxiliary Voltage Input and Output

Table 40. Auxiliary voltage input and output

Characteristic	Value
Input voltage range (auxiliary voltage input)	20. . . 30VDC
Maximum current consumption (auxiliary voltage input)	500mA
Maximum current consumption in power-save mode (auxiliary voltage input)	120mA
Output voltage (auxiliary voltage output)	typ. 23 V
Maximum output current (auxiliary voltage output)	200mA
Resistance of common ground vs. earth	typ. 500 k Ohms
Resistance of common ground vs. earth (floating version)	> 10M Ohms
Capacitance of common ground vs. earth	typ. 100 nF
Maximum allowed voltage of common ground vs. earth	max. 40 Vs
Fuse (Fuse F1, see Figure 69)	1 A slow (Littelfuse 454 NANO2 Slo-Blo R)

Ground potential is the common ground of the controller and the analog inputs and outputs.

The auxiliary voltage output can be set in menu P6.5 (see Section 8.5).

The power-save mode is defined as follows:

- No power supply (the controller is powered exclusively through the 24V auxiliary voltage input).
- The backlight of the LCD display switches off automatically.
- No additional hardware options included (Profibus Interface, DeviceNet interface, relay board, etc).
- Binary outputs and the mA output are not enabled; when activating, the respective currents must be added to the total current consumption.

17.6 Connections

17.6.1 Connections for non explosion-proof version

Table 41. Non-explosionproof Connections

Connection	Value
Power/motor:	Industrial plug with 6 pins Screw connection 16A, max. 2,5mm ² , AWG14
Control signals	Industrial plug with 24 pins Screw connection 16A, max. 2,5mm ² , AWG14

Optionally, contacts are available in crimp or cage clamp designs.

17.6.1 Connections for explosion-proof version

Table 42. Explosion-proof Connections

Connection	Value
Power/motor:	terminals with screw connection 16A, 0,5... 4mm ² , AWG20... AWG12
Control signals	terminals with screw connection 4A, 0,5... 2,5mm ² , AWG20... AWG14

17.7 Miscellaneous

Table 43. Miscellaneous

Characteristic	Value
Ambient temperature	
non explosion-proof version	-25 ... +60°C
explosion-proof version	-20 ... +40°C (according EN 60079-0)
ex version with extended temperature range	-40 ... +60°C
Protection according to EN 60529:	IP67
Standard color:	RAL7024

TYPE		FL-05	FL-15	FL-25	FL-40
Max Electric Thrust	lbs.(kN)	1124(5)	3372(15)	5620(25)	10116(45)
Max Modulating Thrust	lbs.(kN)	674(3)	1798(8)	2697(12)	3372(15)
End of Spring Linear Fail-Safe Thrust	lbs.(kN)	1124(5)	1798(8)	2697(12)	6744(30)
Fail-Safe Spring Return Direction		Linear shaft extending retracting			
Fail-Safe Trigger		Loss of 24 V DC fail-safe command signal or main power supply (selectable)			
Adjustable Operating Time(Electric)	mm/sec	0.21 - 5.8 mm/s			0.15 - 4.5 mm/s
Fail-Safe Spring Rate / Field Adjustable	sec	1 - 3	1 - 5	2 - 10	
Max Linear Travel	inch (mm)	1.18(30)	2.0(50.8)	4.0(101.6)	4.0(101.6)
Operation Mode	On/Off Duty	S2			
	Modulating Duty	S9			
Manual Override		Optional			
VALVE-MOUNTING					
Mounting Base	ISO 5210/ DIN 3358	F07/F10	F10/F12	F10/F14	F14
Stem		M 16x1.5	M 16x1.5	M 16x1.5	M 20x1.5
OPERATING CONDITIONS					
Ingress Protection		IP66 (NEMA 4x), IP67 (NEMA 6), IP68			
Ambient Temperature		- 40° C (-40°F) to +60°C (140°F)			
HOUSING					
Material		Aluminum, NEMA 4X, 6			
Enclosure		Weather-proof / Explosion-proof (optional)			
Certifications		1ph, 24VD – CSA NEC 500 / NEC505, ATEX, IECEx, LVD 3ph - ATEX			1ph, 24VD – CSA NEC 505, ATEX
Coating		High quality two component polyurethane paint system-C3 ISO12944-5			
Approximate Weight	lbs. (kg)	85 (39)	105 (48)	187 (85)	352 (160)
MOTOR - BRUSHLESS TECHNOLOGY					
Isolation Class		Insulation class F, max 155° C (311°F) permanent temperature			
Power Supply	V	24 - 230 VDC, 1x 115 - 230 VAC, 50 - 60Hz, 3x 380 - 480 VAC, 50 - 60 Hz 24 VDC (option not available with FL-40)			
Current Consumption	A	2.5			
Power Consumption idle with fail-safe brake energized	W	36	40	40	40
ACTUATOR CONTROL					
Technology		Integrated processor control unit with frequency technology for variable speed control			
Control Unit					
Control Elements		<ul style="list-style-type: none"> · With additional language independent symbols · Selector switch LOCAL - OFF- REMOTE (lockable) · Control switch OPEN - STOP - CLOSE contact less sensor technology 			
Control Function		<ul style="list-style-type: none"> · Full stroke test · Partial stroke test 			
Local Display		Backlit LCD display, can be rotated in 90 degree steps			
LEDs		4 programmable red, green, blue LEDs for operation - readiness - warning - and error messages			
Communication		Infrared communication interface and Bluetooth technology including Android App for simple configuration			
Control					
Inputs		<ul style="list-style-type: none"> · 5 configurable binary (discrete inputs) control inputs: OPEN - STOP - CLOSE - EMERGENCY OPEN - EMERGENCY CLOSE · Nominal voltage 24VDC 			
Status Indication					
Outputs		<ul style="list-style-type: none"> · 8 configurable binary (relay) outputs: READY - OPEN - CLOSE - RUNNING OPEN - RUNNING CLOSE - TORQUE - LOCAL - REMOTE · Power supply 24 VDC +/- 6V (selectable internal or external) 			
Voltage Input and Output					
Power Supply - External		<ul style="list-style-type: none"> · Input power range: 20-30VDC max current consumption 320mA or 100mA in current save mode · Status indication also in case of a main power supply failure 			
Power Supply - By Actuator		<ul style="list-style-type: none"> · Output voltage: typical 22V max output current 150mA · Reference ground is the common ground of the control unit and of the analog inputs and outputs 			
Functions					
Standard		<ul style="list-style-type: none"> · Switch-off mode adjustable, travel or torque dependent · Torque adjustable: 25-100% of max torque · Adjustable speed for process optimization and emergency speeds · Password protection (reading and/or writing) · Multilingual display · Status indication for binary inputs/outputs and analog signals on LCD display · Data logging for analysis and service · Motor protection by positive temperature coefficient sensors 			
Electrical Connection					
Cable Entry		3 metric threaded boreholes for cable glands: Weather-proof 1xM40, 1xM32, 1xM25 / Explosion-proof 1xM40 + 2xM20			
OPTIONS					
Digital Communication		Modbus RTU, ProfiBus, ProfiNet, Foundation FieldBus HART Platforms			
Relay Board		250 VAC, 2A with 4 outputs			
Analog Position Transmitter		0/4-20mA (2-wire)			
Coating		4 layer with Epoxy under coat for increased corrosion protection – C5-I, C5-M ISO12944-5			

World Area Configuration Centers (WACC) offer sales support, service, inventory and commissioning to our global customers. Choose the WACC or sales office nearest you:

NORTH & SOUTH AMERICA

19200 Northwest Freeway
Houston TX 77065
USA
T +1 281 477 4100

Av. Hollingsworth
325 Iporanga Sorocaba
SP 18087-105
Brazil
T +55 15 3413 8888

ASIA PACIFIC

No. 9 Gul Road
#01-02 Singapore 629361
T +65 6777 8211

No. 1 Lai Yuan Road
Wuqing Development Area
Tianjin 301700
P. R. China
T +86 22 8212 3300

MIDDLE EAST & AFRICA

P. O. Box 17033
Jebel Ali Free Zone
Dubai
T +971 4 811 8100

P. O. Box 10305
Jubail 31961
Saudi Arabia
T +966 3 340 8650

24 Angus Crescent
Longmeadow Business Estate East
P.O. Box 6908 Greenstone
1616 Modderfontein Extension 5
South Africa
T +27 11 451 3700

EUROPE

Holland Faszor 6
Székesfehérvár 8000
Hungary
T +36 22 53 09 50

Strada Biffi 165
29017 Fiorenzuola d'Arda (PC)
Italy
T +39 0523 944 411

For complete list of sales and manufacturing sites, please visit www.emerson.com/actuationtechnologieslocations or contact us at info.actuationtechnologies@emerson.com

www.emerson.com/bettis

©2019 Emerson. All rights reserved.

The Emerson logo is a trademark and service mark of Emerson Electric Co. Bettis™ is a mark of one of the Emerson family of companies. All other marks are property of their respective owners.

The contents of this publication are presented for information purposes only, and while every effort has been made to ensure their accuracy, they are not to be construed as warranties or guarantees, express or implied, regarding the products or services described herein or their use or applicability. All sales are governed by our terms and conditions, which are available on request. We reserve the right to modify or improve the designs or specifications of our products at any time without notice.

BETTIS™

