



CustomControlSensors

Hazardous Areas Adjustable Temperature Switch

646TUE* - Capillary



Capillary not shown.

DESCRIPTION

- Highly reliable devices utilizing the CCS Dual-Snap® Belleville disc spring principle pioneered by CCS' engineers.
- Engineering based on aerospace technology.
- Rigid and internally adjustable for convenient field set point adjustment.
- Repeatable and stable set points.
- Vibration and shock resistant.
- High cycle life.
- High over-temperature capability.
- Certified explosion proof hermetically sealed electrical assembly for environmental protection.
- Various options for electrical ratings to meet a wide range of application requirements.

SHIPPING WEIGHT: APPROXIMATELY 68 OUNCES (1928 GRAMS)

SERIES:

646TUE*

ADJUSTABLE SET POINT RANGE: TEMPERATURE:

-39° to 630°F
-39° to 332°C

OPERATING TEMPERATURE:

-40° to 186°F
-40° to 86°C

STANDARD FEATURES:

- CE Mark
- CCC
- NACE MR0175 / ISO 15156
- NEMA: 4, 7, 9, 13 / IP66
- U.L. / CSA Listed
- Hermetically Sealed Electrical Assembly

INSTALLATION DRAWING

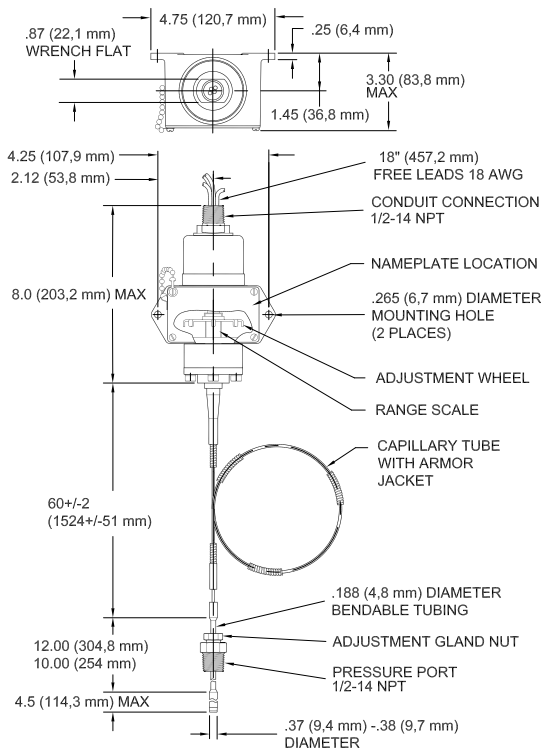

DESIGN PRINCIPLES

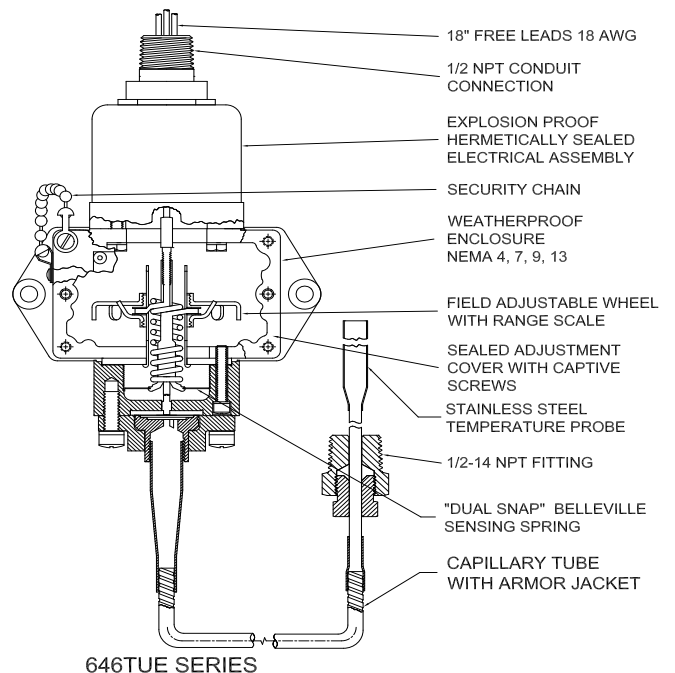

FIELD SETTING: Open access cover. Adjust wheel as illustrated. Clockwise to increase settings. Counterclockwise to decrease settings.

NOTE: DO NOT USE ELECTRICAL HEX FOR TORQUING.





CustomControlSensors

Hazardous Areas Adjustable Temperature Switch

646TUE* - Capillary

OPERATING AND ORDERING DATA

SERIES 646TUE*	WETTED PARTS: 300 STAINLESS STEEL AND GRAPHITE TEMPERATURE PROBE WITH LUBRICATED GLASS FIBER CAPILLARY TUBE				
	ADJUSTABLE SET POINT RANGE		APPROXIMATE DEAD BAND		MAXIMUM PROBE TEMPERATURE DEGREES F (DEGREES C)
	INCREASING TEMPERATURE DEGREES F (DEGREES C)	DECREASING TEMPERATURE DEGREES F (DEGREES C)	AT BOTTOM OF RANGE DEGREES F (DEGREES C)	AT TOP OF RANGE DEGREES F (DEGREES C)	
646TUE*1	-30° to +55° (-34° to +13°)	-39° to +52° (-39° to +11°)	9° (5°)	3° (2°)	+150° (66°)
646TUE*2	+35° to +140° (+2° to +60°)	+21° to +135° (-6° to +57°)	14° (8°)	5° (3°)	+300° (+149°)
646TUE*3	+90° to +210° (+32° to +99°)	+75° to +205° (+24° to +96°)	15° (8°)	5° (3°)	+300° (+149°)
646TUE*4	+175° to +310° (+79° to +154°)	+159° to +305° (+71° to +152°)	16° (8°)	5° (2°)	+500° (+260°)
646TUE*5	+275° to +420° (+135° to +216°)	+256° to +414° (+124° to +212°)	19° (11)	6° (4)	+500° (+260°)
646TUE*6	+380° to +525° (+193° to +274°)	+355° to +520° (+179° to +271°)	25° (14°)	5° (3°)	+600° (316°)
646TUE*7	+480° to +630° (+249° to +332°)	+456° to +624° (+236° to +329°)	24° (13°)	6° (7°)	+650° (343°)

EXTERNAL PROBE PRESSURE:

System Pressure: 1250 PSIG (86 bar) Proof Pressure: 1500 PSIG (103 bar)

HOW TO ORDER

Follow these steps to build your part number:

1. Specify the series based on your required set point, range, dead band, system pressure and proof pressure.
2. Add desired options model code letter.
3. Add the applicable standard suffix number.

(Ex: 646TUEM4-7002)

TEMPERATURE CONVERSION

32 Deg F = 0 Deg C

CERTIFICATIONS

Consult CCS website for complete certification and approval listing.

OPTIONAL STANDARD MODIFIED SUFFIXES

- 7001:** 10' Capillary
- 7002:** 15' Capillary
- 7003:** 25' Capillary
- 7008:** Gold Contacts
- 7076:** 18 inch Teflon Free Leads Standard 5' Capillary (Low Temp Wire)

OPTIONS MODEL CODES

- M:** DPDT Electrical
- Y:** ATEX / GOST Certified Electrical Assembly (Consult CCS Sales Department for GOST options and requirements.)
- X:** Double Break Electrical Assembly

Note: Additional modified standard suffixes are available, consult CCS sales department or CCS Representative.

THERMOWELLS

Order as separate line items. See accessory page for detailed information.

- 113-34-1:** 1" NPT 316 SST 4.5" "U" Dim.
- 113-34-2:** 1" NPT 316 SST 7.5" "U" Dim.
- 113-34-3:** 1" NPT 316 SST 10.5" "U" Dim.
- 113-34-4:** 1" NPT 316 SST 13.5" "U" Dim.
- 113-35-1:** 3/4" NPT 316 SST 4.5" "U" Dim.
- 113-35-2:** 3/4" NPT 316 SST 7.5" "U" Dim.
- 113-35-3:** 3/4" NPT 316 SST 10.5" "U" Dim.
- 113-35-4:** 3/4" NPT 316 SST 13.5" "U" Dim.

ELECTRICAL CHARACTERISTICS

* c-UL, U.L./CSA Explosion Proof: Div. 1, 2 hermetically sealed electrical assembly P/N 17-51 (17-73 for M model option), listed by both Underwriter's Laboratories, Inc. (File No. E32961) and Canadian Standard Association (CSA) Testing Laboratories (File No. LR22921) for hazardous locations, Class 1, Groups A, B, C, and D; Class 2 Groups E, F, and G.

* ATEX - Baseefa certified for potentially explosive atmospheres. Models 646**Y, II 2 GD Ex d IIC, Ex tb IIIC, Baseefa 05ATEX0011X. (Option Y)

ELECTRICAL CHARACTERISTICS SCHEMATIC AND WIRING CODE

RATING OF SWITCH ELEMENT

VOLTS	AMPERES		
	SPDT Res.	DPDT "M" Res.	Dbl Brk "X" Res.
125 AC - 50/60 Hz	15	5	15
250 AC - 50/60 Hz	15	5	15
480 AC - 50/60 Hz	15	-	15
28 DC	.2	.5	-
125 DC	.5	.5	1
250 DC	.2	-	.5
*125 AC - 50/60 Hz	1 max	1 max	-
*30 DC	1 max	1 max	-

*Gold Contacts -7008 Suffix

