

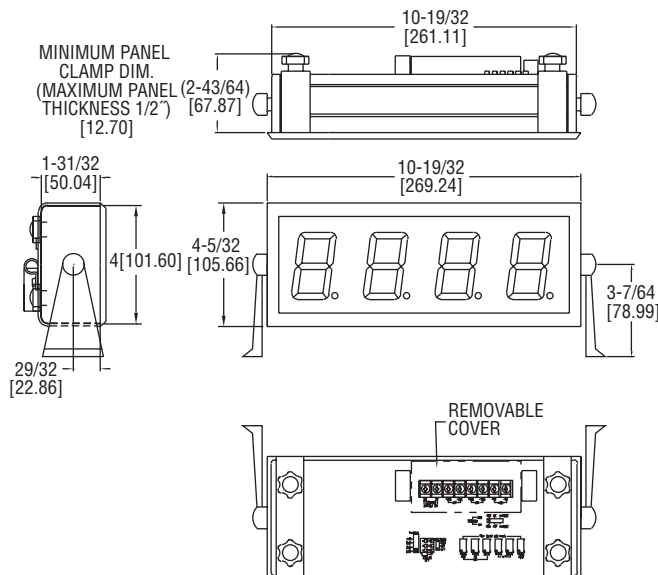

## Series DPMX Extra Large Digital Panel Meter

### Specifications - Installation and Operating Instructions



The Series DPMX Extra Large LED Digital Panel Meter can easily be viewed from across a room or in dark areas. The 2.3" LED segments are available in red, green, or blue. These panel meters come equipped with a universal power supply and user selectable process inputs to fit most applications. The Series DPMX includes a mounting bracket that can be adjusted up to 180°.

#### INSTALLATION

The Series DPMX is designed to be bezel mounted or gimbal mounted. Mounting brackets are included in the box.

#### BEZEL MOUNT

Remove the two U-brackets from the back of the panel meter. Slide the unit through the panel from the front. Next, attach the U-brackets to the rear and tighten the four retaining bolts. See Figure 1 for dimensions of the cutout.

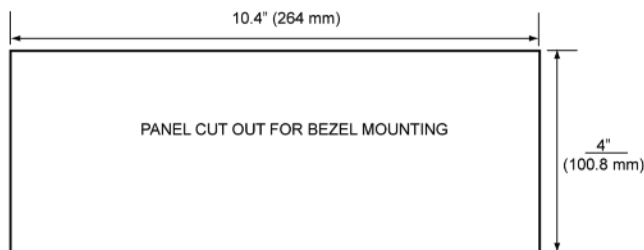

Figure 1

#### GIMBAL MOUNT

If the panel meter is to be gimbal mounted, remove and discard the two U-brackets from the back of the panel meter. Fasten the gimbal brackets to the mounting surface using appropriate hardware. Lastly, fasten the panel meter loosely to the gimbals using the thumbscrews. Note that detents are provided on both sides of the case. Adjust the meter to the desired viewing angle and securely tighten the thumb screws.

#### SPECIFICATIONS

##### Inputs Ranges:

Set Voltage:  $\pm 200$  mVDC,  $\pm 2$  VDC,  $\pm 20$  VDC;  
Adjustable Voltage: 200 mVDC, 5 VDC, 10 VDC;  
Adjustable Current: 0(4) to 20 mA DC.

##### Inputs Impedance:

Set Voltage:  $>1$  M $\Omega$  ( $>10$  M $\Omega$  on 200 mV range);  
Adjustable Voltage: 392 k $\Omega$ ;  
Adjustable Current: 300 $\Omega$  nominal.

##### Accuracy: $\pm(1\%$ FS + 1 count).

**Power Supply:** 90 to 250 VAC @12 VA or 10.5 to 30 VAC/DC @ 6VA (depending on model).

**Display:** 3-1/2 digits, 2.3" height, 7 segment LED.

**Sampling Rate:** 3 readings per second.

**Operating Temperature:** -10 to 50°C.

**Storage Range:** -40 to 75°C.

**Warm Up:** 10 minutes.

**Mounting:** 180° gimbal mounting with 30° stops or bezel mount.

#### WIRING

The unit accepts signal inputs of 200 mVDC, 2 VDC, 5 VDC, 20 VDC, 10 VDC, and a 4 to 20 mA DC loop. The screw terminals for wiring are located on the back of the adder board beneath the cover. The cable clamps must be unfastened to access the screw terminals. In order to reduce electrical noise, install the line voltage and the process signal through separate cable clamps as shown in Figure 2.

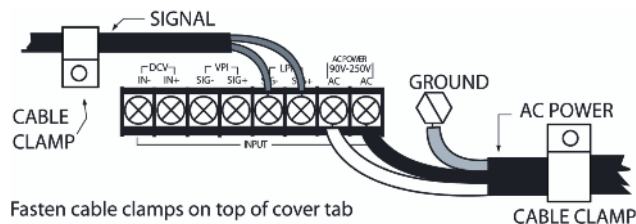

Figure 2

On the terminal cover, remove two thin break out sections that best match the diameter of the wiring cables being used.

**OPERATION**

**FUNCTION**

The Series DPMX panel meter can be used with voltage or current signal inputs. It is important that the signal wires be connected to the proper terminals as labeled in Figure 2. Along with wiring to the proper terminals, the proper input should be selected using the function selection switch shown in Figure 3. For current inputs, the function switch should be set to LPI. For adjustable voltage inputs, the function switch should be set to VPI. For fixed voltage inputs, the function switch should be set to DCV.

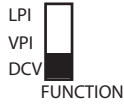

**Figure 3**

**ZERO SUPPRESSION FOR CURRENT INPUT**

The Series DPMX can be used with either 0 to 20 mA or 4 to 20 mA current inputs. In order to maximize the rangeability of the meter, the LPI offset jumper should be set to "+" for 4 to 20 mA signal inputs or "-" for 0 to 20 mA inputs. See Figure 4.

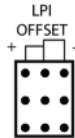

**Figure 4**

**SELECTING DECIMAL POINT POSITION**

Four decimal point positions are available on the digital panel meter, DP1-OFF. Move the switch to the corresponding decimal point location. See Figure 5.

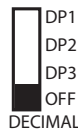

**Figure 5**

**SELECTING VOLTAGE INPUT RANGE**

Three input positions are available for either VPI or DCV (see Figure 3 above). Move the switch to desired input range (see Figure 7).

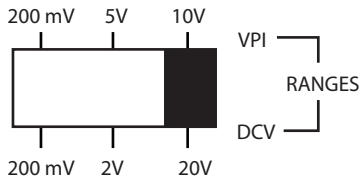

**Figure 7**

**SPAN & ZERO ADJUSTMENT**

The unit is equipped with a span adjustment for DCV inputs, and both span and zero adjustments for LPI and VPI inputs. To use either function, a flathead screwdriver is required to set the appropriate values. First, choose the span and/or zero adjustment that corresponds with the input that is being supplied. For example, if a VPI inputs is being supplied to the meter, you will need to adjust the VPI span. Next, apply the lowest input into the meter and adjust the zero position for the required reading. After adjusting the zero position, apply the highest input into the meter and adjust the span position for the meter. Recheck the zero input and readjust as needed. See Figure 6.

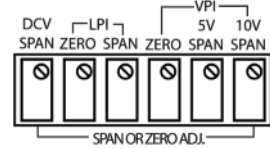

**Figure 6**

**MAINTENANCE**

Upon final installation of the Series DPMX LED Digital Panel Meter, no routine maintenance is required. A periodic check of the system calibration is recommended. The Series DPMX is not field serviceable and should be returned if repair is needed (field repair should not be attempted and may void warranty). Be sure to include a brief description of the problem plus any relevant application notes. Contact customer service to receive a return goods authorization number before shipping.

**CAUTION!** Do not mount the panel meter outdoors or in damp environments, or other extreme environments. It is not a sealed unit.