

CONTROLINC Quick Startup Guide

Table of Contents

Section 1: Quick Start Guide

1.1	Setup Instructions.....	9
1.2	Entering Setup Mode	9
1.3	Changing Setup Parameters.....	9
1.4	Exiting Setup Mode	9
1.5	Direct Command Mode.....	10
1.6	Valve Control Mode	10
1.7	Valve Travel Limits	11
1.8	ESD Function.....	11
1.9	ESD/Monitor Relay Function.....	12
1.10	ESD Trigger Sources	12
1.11	ESD Delay Time	13
1.12	Position Control Bandwidth.....	14
1.13	Speed Control Bandwidth	14
1.14	Motor Starter Type	15
1.15	Analog Output Control.....	15
1.16	Modulation Delay Time	15
1.17	Network Response Delay Time	16
1.18	Torque Retry (Log-Jam) Control.....	16
1.19	Network Baud Rate	17
1.20	Network Parity.....	18
1.21	Calibrate Analog I/O.....	18
1.22	Calibrate Analog Inputs.....	19
1.23	Calibrate Analog Output	19
1.24	Load Factory Default Calibrate Values	20
1.25	User Relay #1 Application	20
1.26	User Relay #2 Application	21
1.27	LSA Position Setpoint	22
1.28	LSB Position Setpoint	22
1.29	Anti-water Hammer	23
1.30	Opening Duty Cycle ON Timer.....	23
1.31	Opening Duty Cycle OFF Timer.....	24
1.32	Closing Duty Cycle ON Timer.....	24
1.33	Closing Duty Cycle OFF Timer.....	25
1.34	Write Protect	26
1.35	Setpoint Tracking	26

Section 2: Modbus Memory Map Reference

2.1	Modbus Function Codes.....	27
2.2	Input Register Map.....	27
2.3	Input Register 03 (DCM320B only)	28
2.4	Discrete Input Map.....	28
2.5	Coil Map.....	29
2.6	Holding Register Map.....	30

Section 3: Network Installation Guide

Section 4: System Startup Guide

Section 5: Optional Phase Monitor

Section 6: Alarm Definitions and Troubleshooting Guide

Preface

DCM320B is an upgrade of DCM320A. It is a fit, form, and function replacement for the DCM320A. The DCM320B may be used as a direct replacement of the DCM320A in existing installations. The primary difference is the DIP switch configuration method. The DCM320B provides more range and resolution of most configuration parameters. This handy reference is a guide to help you get your system up and running quickly. Refer to the wiring diagram supplied with the actuator for detailed wiring information. The first section of this guide will help you get your Controlinc actuators hooked-up and set-up correctly. If you need to change configuration of the unit, we recommend using our Windows based DCMLink rather than setting configuration DIP switches shown in this guide. Setting network station address DIP switches is required. The second section of this manual is the Modbus memory map reference to help configure your host database. If you are using the Controlinc Network Master, then refer to the manual supplied with that unit for memory maps. Section three of this manual is a brief system startup guide to help you do things in the proper order to achieve a successful system startup. This last section also covers optional phase monitor module. This document covers Revision F and later revision boards.

WARNING

Failure to follow instructions for proper electrical wiring, storage, setup, and maintenance may cause serious injury, damage equipment, or void the warranty. Refer to Manual E796 for instructions on storage, electrical hook-up, and maintenance.

Section 1: Quick Start Guide

Step 1: Identify network topology

Identify network topology from Figures 2 and 3 on page 5 and note the ports being used (Ports A,B,C,D). Refer to page 23 for guidance on network planning and installation.

Step 2: Set network jumpers and switches

If network topology is parallel bus, then remove network termination and bias by turning OFF S1 and S2 of SW4 on the DCM 320B card. Remove jumpers JP1 and JP2 on the CAM05, if installed. Terminations must be left in the most distant unit on the network. If E>Net is selected, all ports must be terminated. Baudrate range selection is not required on DCM 320B but is required on CAM05. Refer to Figure 5 on page 5 for jumper and DIP switch locations.

Step 3: Connect network wiring (Refer to page 23 for guidance)

Wire network ports selected in Step 1. Refer to Figure 4 when wiring Ports A and B on TBM 320A module. Refer to Figure 5 when wiring Ports C and D on the CAM05 module.

Step 4: Connect auxiliary I/O wiring

Refer to Figure 4 on page 6 when connecting discrete auxiliary I/O wiring. Note that some functions must be jumpered between screw terminals if not wired to external contacts. Analog I/O wiring is connected to the DCM 320B module as shown in Figure 5.

Step 5: Set network station address

Each node (valve actuator) on the network must have a unique station address. Locate DIP switch SW1 on the DCM 320B card shown in Figure 5. Locate the desired station address on pages 6 and 7. Set the DIP switches of SW1 to the corresponding pattern shown beside the selected address. Press execute button to store address.

NOTE:

We highly recommend using the windows based DCMLink to configure the actuators. DCMLink is available at www.emerson.com or your local Actuation Technologies distributor.

If using DCMLink, you may skip step 6 below.

Figure 1 DCMLink Homescreen

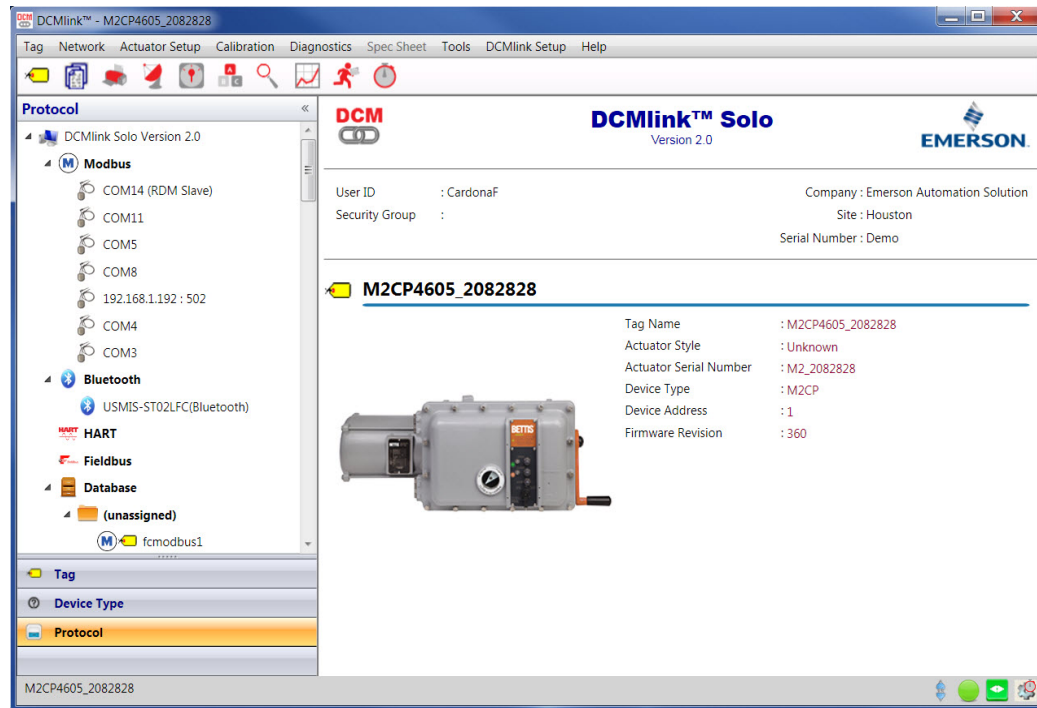

Step 6: Select configuration parameters

The actuator may be configured using the 5 DIP switches of SW2 and 8 DIP switches of SW1. This is a back-up means of configuring the unit if DCMLink is not available. The actuator is normally shipped with factory default settings. These settings may be changed by the following procedure. Locate DIP switches SW1, SW2, and Setup Execute Button on the DCM 320B module shown in Figure 5. Place the Selector Switch in the "OFF" position. Select the feature or configuration parameter from the configuration tables in this manual. Set the DIP switches per the corresponding switch pattern and then press the execute button. If the configuration parameter is valid, the green (setup data good) LED will flash. If error data is entered, the red (setup data error) LED will light until the error is corrected. Repeat this procedure for each parameter to be revised. Return all 5 DIP switches of SW2 to the OFF position and return the 8 DIP switches of SW1 to the network station address when configuration is complete. With all SW2 switches OFF and the address switches set, press the execute button to store the network address to nonvolatile configuration memory.

Figure 2 Controlinc Model 320B RS485 Network Topology Options

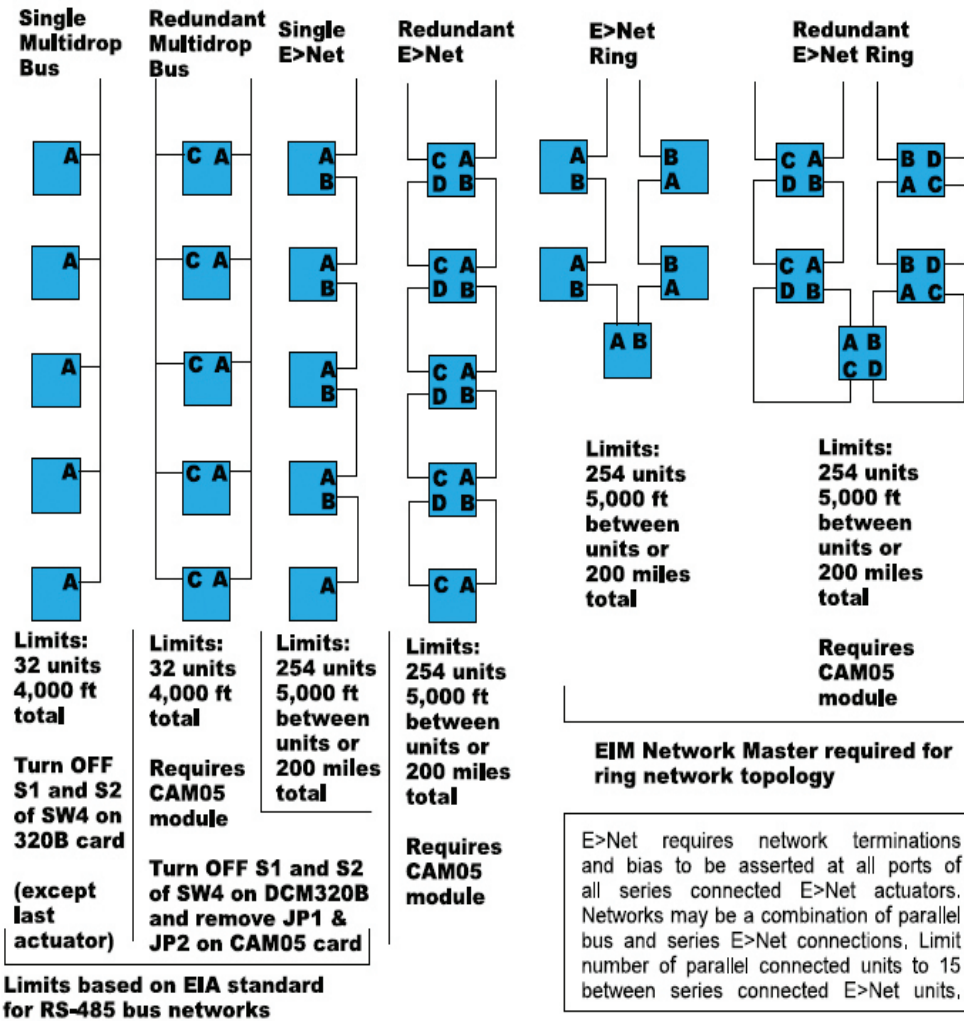

Figure 3

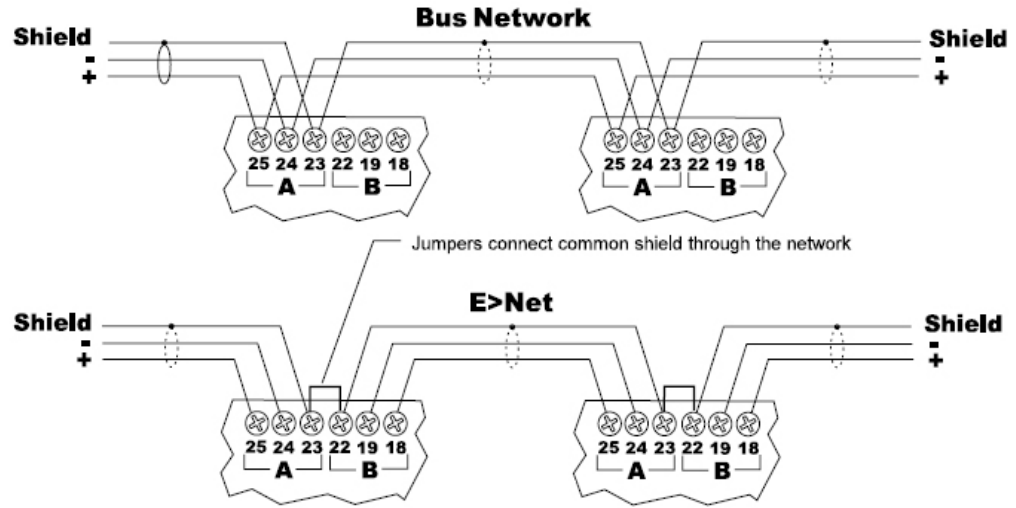
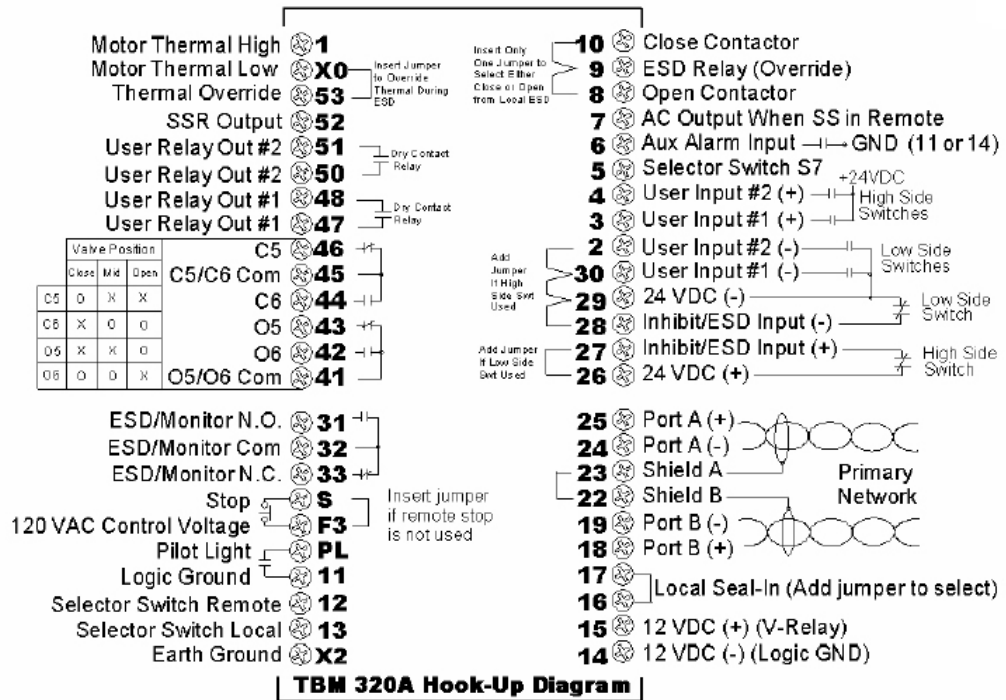

Figure 4 TBM 320A Hook-up Diagram



NOTE:

TBM320A is used with both DCM320A and DCM320B.

Figure 5

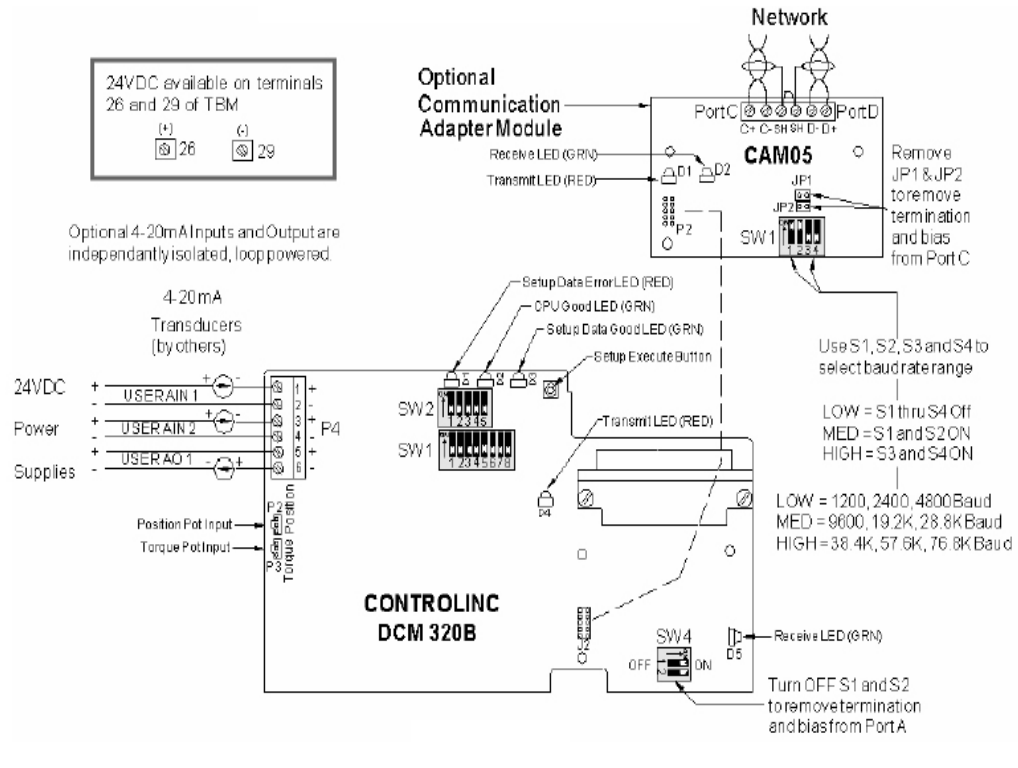

Figure 6 Configuration Data and Network Station Address (SW1)































































































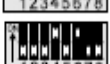
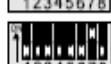

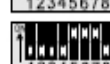
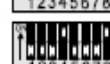















































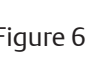

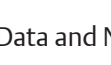

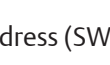
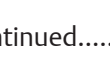











































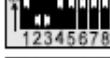









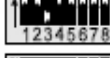









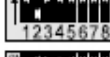



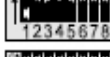





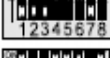





















	1		25		49		73		97		121
	2		26		50		74		98		122
	3		27		51		75		99		123
	4		28		52		76		100		124
	5		29		53		77		101		125
	6		30		54		78		102		126
	7		31		55		79		103		127
	8		32		56		80		104		128
	9		33		57		81		105		129
	10		34		58		82		106		130
	11		35		59		83		107		131
	12		36		60		84		108		132
	13		37		61		85		109		133
	14		38		62		86		110		134
	15		39		63		87		111		135
	16		40		64		88		112		136
	17		41		65		89		113		137
	18		42		66		90		114		138
	19		43		67		91		115		139
	20		44		68		92		116		140
	21		45		69		93		117		141
	22		46		70		94		118		142
	23		47		71		95		119		143
	24		48		72		96		120		144

Figure 6 Configuration Data and Network Station Address (SW1) continued.....

 145	 169	 193	 217	 241
 146	 170	 194	 218	 242
 147	 171	 195	 219	 243
 148	 172	 196	 220	 244
 149	 173	 197	 221	 245
 150	 174	 198	 222	 246
 151	 175	 199	 223	 247
 152	 176	 200	 224	 248
 153	 177	 201	 225	 249
 154	 178	 202	 226	 250
 155	 179	 203	 227	 251
 156	 180	 204	 228	 252
 157	 181	 205	 229	 253
 158	 182	 206	 230	 254
 159	 183	 207	 231	 255
 160	 184	 208	 232	<p>To store network station address to nonvolatile configuration memory, set all SW2 switches to OFF, set SW1 switches to the desired address, place selector switch in OFF position and then press execute button.</p> <p>Addresses 0 and 255 are reserved for broadcast, Address 254 is reserved on secondary port.</p>
 161	 185	 209	 233	
 162	 186	 210	 234	
 163	 187	 211	 235	
 164	 188	 212	 236	
 165	 189	 213	 237	
 166	 190	 214	 238	
 167	 191	 215	 239	
 168	 192	 216	 240	

1.1 Setup Instructions

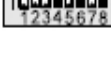
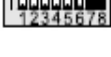
The DCM 320B is factory configured as specified by the customer purchase order. If field setup changes are required, follow setup instructions below. If unsure about setup of a module, known factory default settings may be reloaded as shown under "Direct Command Mode". When executed, the module loads known parameters from program memory to EEPROM configuration memory. Default parameters are highlighted in this manual by a box around the default or the value is listed.

1.2 Entering Setup Mode

Locate DIP switches SW1, SW2, Setup Execute Button and LED indicators on the DCM 320B (See Figure 5 on page 5). SW2 switches select mode and SW1 switches select setup parameters and network station address.

- 1) Record network station address of SW1. These switches must be returned to the same setting before exiting setup.
- 2) Place selector switch in the OFF position.
- 3) Select desired setup mode by setting SW2 as indicated on this and following pages.
- 4) Verify the DCM320B has entered setup mode by a rapid flashing CPU GOOD light.

1.3 Changing Setup Parameters

The five switches (S1 - S5) of SW2 select the parameter/mode to be configured. The eight switches of SW1 (S1 - S8) are used to select desired setup data.

- 1) Locate the desired setup parameter to be revised on pages 9 through 22.
- 2) Set the five switches of SW2 per the switch pattern shown for desired mode.
- 3) Set SW1 switches as shown or refer to the switches on pages 6 and 7 for desired value. Selected values are multiples of the stated resolution for each parameter.
- 4) When both SW2 and SW1 switches are set, press the execute button to store the setup parameter to nonvolatile memory.
- 5) Verify the green LED (setup data good) light flashes. If an invalid enter is made, the red LED (setup data error) light will turn on until the error is corrected.

1.4 Exiting Setup Mode

- 1) Turn off all five SW2 switches.
- 2) Place selector switch in the OFF position.
- 3) Return SW1 switches to the Network Station Address recorded in Step 1 under "Entering Setup Mode" above.
- 4) Press the Execute Button.
- 5) Verify the DCM320B has returned to the normal run mode by a slow flashing CPU GOOD light.

1.5 Direct Command Mode

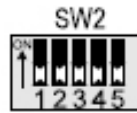

All SW2 switches OFF. Normal run mode. Return all SW2 switches to this position after setup.



S1 ON = Direct Command Mode. Select the desired command by setting SW1 switches as follows.



S1 ON = Reload Factory Defaults, Loads default settings as listed or designated by rectangle around description under each setup mode parameter in this manual.



S2 ON = Reset passcode protection.



S1,S2 ON = Archive Torque Profile. Stores torque profile to EEPROM for later retrieval by host computer.

1.6 Valve Control Mode

(Setpoint Source)

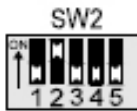

S2 ON = Valve Control Modes. Select the desired control mode by setting SW1 switches as follows.



All SW1 switches OFF = Remote Host Control. Host may write Setpoint or Open, Stop, Close. Required by F.Fieldbus for modulating control.



S1 ON = Control from AIN1 (Torque Analog Input). Position control with Potentiometer or 0-5V signal connected to P3.



S2 ON = Control from AIN2 (User Analog Input #1). Position control with 4-20mA signal connected to P4-2.



S1,S2 ON = Control from AIN3 (User Analog Input #2). Position control with 4-20mA signal connected to P4-4.





S3 ON = Block Valve Control Mode. Required by Foundation Fieldbus for discrete control mode.





S1,S3 ON = Pulse Input Control Mode. 24VDC discrete control wired to User Input #1 (OPEN) and User Input #2 (CLOSE).

1.7 Valve Travel Limits

SW2
 S1,S2 ON = Valve Travel Limits Mode.

SW1
 All switches OFF = Open and Close Position Limits. Open to LSO and Close to LSC.

SW1
 S1 ON = Enable close valve torque seat. Open to LSO and Close to TSC.

SW1
 S2 ON = Enable torque backseat. Open to TSO and Close to LSC.

SW1
 S1,S2 ON = Enable close torque seat and torque backseat, Open to TSO and Close to TSC.

1.8 ESD Function

SW2
 S4 ON, Select ESD Function setup mode.

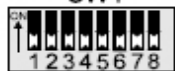
SW1
 All SW1 switches OFF, Stay-Put (Stop) and do not operate ESD relay. Factory default.

SW1
 S1 ON, Go closed on ESD and do not operate ESD relay.

SW1
 S2 ON, Go open on ESD and do not operate ESD relay.

SW1
 S1,S2 ON, Go closed on ESD and operate ESD relay.

SW1
 S3 ON, Go open on ESD and operate ESD relay.

SW1
 S1,S3 ON, Stay-Put and operate ESD relay. Do not operate close or open outputs.

1.9 ESD/Monitor Relay Function

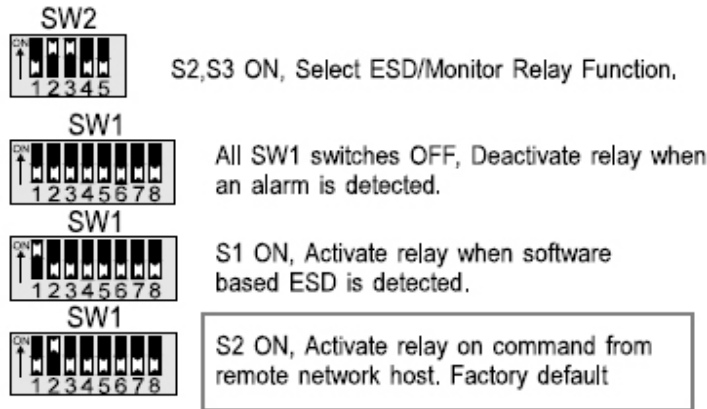

1.10 ESD Trigger Sources

NOTE:

At least one source must be selected, or ESD is disabled.

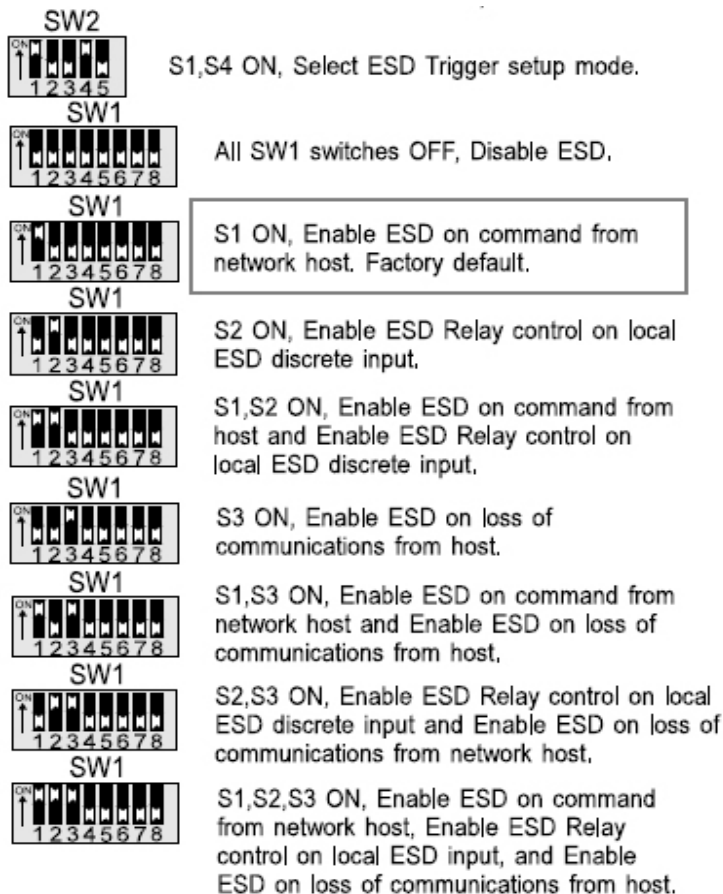

1.11 ESD Delay Time

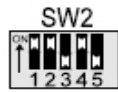

S1,S2,S4 ON, Select ESD delay setup mode.

Select delay time by setting SW1 switches as shown on Pages 7 and 8 .
(See example below)

Range = 0 to 60 Seconds

Resolution = 1 Seconds

Default = 0

Example: Set ESD delay time to 30 seconds.



Locate the DIP switch pattern for 30 on Page 7 .

NOTE:

ESD Delay Time applies only to software generated ESD and not to the hardwired local ESD input.

Notes on hardwired Local Inhibit/ESD:

- 1) Local ESD is a hardwired closed loop circuit wired to TBM terminals 27 (+) and 28 (-) using either an external 24VDC power supply or the internal 24VDC power available at terminals 26(+) and 29(-). See Figure 4.
- 2) Local ESD will inhibit control from the DCM320B module, local push buttons and selector switch. To force valve closed on local ESD, insert jumper between terminals 9 and 10. To force valve open on local ESD, insert jumper between terminals 8 and 9. Actuator will Stop (Stay-Put) if no jumpers are inserted between terminals 8-9 or 9-10.
- 3) To override motor thermal contacts during local ESD, insert jumper between terminals XO and 53.

⚠ WARNING:

Do not override thermals in a hazardous area.

- 4) Software activated ESD can activate Local ESD by wiring N.C. contacts of ESD/Monitor relay (terminals 32 & 33) in series with Local Inhibit/ESD inputs at terminals 27 and 28.

1.12 Position Control Bandwidth

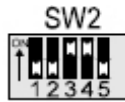

S3,S4 ON, Select position control bandwidth (Deadband) setup mode.

Select bandwidth by setting SW1 switches as shown on Pages 7 and 8 .
(See example below)

Range = 0,1 to 5,0% (0-50)
Resolution = 0,1%
Default = 1,0%

Example: Set control bandwidth to 2.5%.



Locate the DIP switch pattern for 25 on Page 7 , i.e. 25 x 0.1% resolution = 2.5%.

1.13 Speed Control Bandwidth



S1,S3,S4 ON, Select speed control bandwidth setup mode.

Select bandwidth by setting SW1 switches as shown on Pages 7 and 8 .
(See example below)

Range = 0.3 to 10.0% (3-100)
Resolution = 0,1%
Default = 3,0%

Example: Set speed control bandwidth to 5%.





Locate the DIP switch pattern for 50 on Page 7 , i.e. 50 x 0.1% resolution = 5.0%.

NOTE:

Speed control bandwidth is meaningful only when a VFD motor starter is used. Speed control bandwidth must be greater than position control bandwidth.

1.14 Motor Starter Type

SW2
 S1,S2,S3 ON, Select type of motor starter installed. Select motor starter type by setting SW1 switches.

SW1
 All SW1 switches OFF, Enable Electro-mechanical motor starter. Factory default.

SW1
 S1 ON, Enable Solid-State Relay (SSR) motor starter type.

SW1
 S2 ON, Enable Variable Frequency Drive (VDF) motor starter type.

1.15 Analog Output Control

SW2
 S3 ON, Select source for analog output. Select AO#1 source by setting SW1 switches.

SW1
 All SW1 switches OFF, Enable Network Host control of analog output AO#1. Factory default.

SW1
 S1 ON, Enable Position Feedback control of analog output AO#1.

1.16 Modulation Delay Time

SW2
 S2,S3,S4 ON = Modulation Delay Timer Mode.

Select delay time by setting SW1 switches as shown on Pages 7 and 8 .
 (See example below)

Range = 0 to 25,5 Seconds, (0-255)
 Resolution = 0,1 Second,
 Default = 0.1 Second.

Example: Set modulation delay time to 6 seconds.

SW1
 Locate the DIP switch pattern for 60 on Page 7 ,
 i.e, 60 x 0,1 Sec resolution = 6,0 seconds.

1.17 Network Response Delay Time

1.17.1 Primary Network Ports A and B



S1,S2,S3,S4 ON, Select Ports A & B response delay mode.

Select delay time by setting SW1 switches as shown on Pages 7 and 8 .

Range = 8 to 60mS (8-60)

Resolution = 1mS

Default = 8mS

Example: Set response delay to 15mS



Locate the DIP switch pattern for 15 on Page 7 .

1.17.2 Secondary Network Ports C and D



S5 ON, Select Ports C & D response delay mode.

Select delay time by setting SW1 switches as shown on Pages 7 and 8 .

(See example above)

Range = 8 to 60mS (8-60)

Resolution = 1mS

Default = 8mS

1.18 Torque Retry (Log-Jam) Control



S1,S3 ON, Select Close Torque (Log-Jam) function.

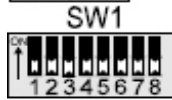

All SW1 switches OFF, Disable close torque retry (Log-jam) function. Factory default.



S1 ON, Enable close torque retry (Log-jam) function.

1.19 Network Baud Rate

1.19.1 Primary Network Ports A and B

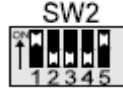

S1,S5 ON Select baudrate for primary network ports A and B.

Select baud rate by setting SW1 switches as shown below, Default = 9600

1.19.2 Secondary Network Ports C and D



S2,S5 ON Select baudrate for secondary network ports C and D.

Select baud rate by setting SW1 switches as shown below. Default = 19200



All off = 1200



S1,2 = 9600

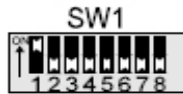

S1 = 2400



S3 = 19200

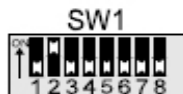

S2 = 4800



S1,3 = 38400

1.20 Network Parity

1.20.1 Primary Network Ports A and B

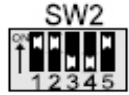

S1,2,5 ON, Select parity for primary network.
Select parity by setting SW1 switches as shown below.

1.20.2 Secondary Network Ports C and D



S3,5 ON, Select parity for secondary network.
Select parity by setting SW1 switches as shown below.



All SW1 switches OFF = No parity



S1 = Even parity

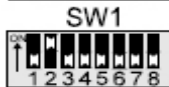

S2 = Odd parity







1.21 Calibrate Analog I/O







S1,3,5 ON, Select analog input and output calibration mode.

Set SW1 to select the desired analog input or output calibration, apply calibration current to input or connect 4-20mA meter to output and then press execute button.







1.22 Calibrate Analog Inputs

- | | |
|--|--|
| SW1
 | S2 ON, Set Torque analog input Zero.
Input zero offset resistance/voltage. |
| SW1
 | S1,2 ON, Set Torque analog input Span.
Input full scale resistance/voltage. |
| SW1
 | S2,3 ON, Set User #1 analog input Zero.
Input 4mA offset current. |
| SW1
 | S1,2,3 ON, Set User #1 analog input Span.
Input 20mA full scale current. |
| SW1
 | S2,4 ON, Set User #2 analog input Zero.
Input 4mA offset current. |
| SW1
 | S1,2,4 ON, Set User#2 analog input Span.
Input 20mA full scale current. |

1.23 Calibrate Analog Output





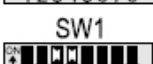
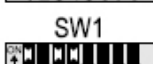
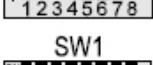



- | | |
|--|--|
| SW1
 | S2,3,4 ON, Increase zero analog output
at AO#1 while the Execute button is pressed. |
| SW1
 | S1,2,3,4 ON, Decrease zero analog output
at AO#1 while the Execute button is pressed. |
| SW1
 | S5 ON, Increase full scale analog output
at AO#1 while the Execute button is pressed. |
| SW1
 | S1,5 ON, Decrease full scale analog output
at AO#1 while the Execute button is pressed. |

1.24 Load Factory Default Calibrate Values

	All OFF, Torque input Zero,		S1 ON, Torque input Span.
	S3 ON, User AIN#1 Zero,		S1,3 ON, User AIN#1 Span.
	S4 ON, User AIN#2 Zero.		S1,4 ON, User AIN#1 Span.
	S3,4 ON, Analog Out Zero.		S1,3,4 ON, Analog Out Span.
	S2,5 ON, Load factory default calibration values for all analog inputs and outputs for both Zero and Span.		

1.25 User Relay #1 Application

 S2,S3,S5 ON, Select User Relay#1 setup mode.
 Select user relay#1 function by setting SW1 switches as shown below.

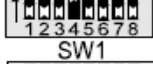
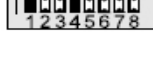
	All SW1 switches OFF, Direct control of N.O. relay from network master. Factory default.
	S1 ON, Activate normally open (N.O.) relay when Selector Switch in Remote position.
	S2 ON, Activate normally open (N.O.) relay when Selector Switch in Local position.
	S1,S2 ON, Activate normally open (N.O.) relay at LSA limit setpoint, if LSA position configured.
	S3 ON, Activate normally open (N.O.) relay when any ESD is active.
	S1,S3 ON, Direct control of normally closed (N.C.) contact from network master.
	S2,S3 ON, Activate normally closed (N.C.) relay when Selector Switch in Remote position.
	S1,S2,S3 ON, Activate normally closed (N.C.) relay when Selector Switch in Local position.
	S4 ON, Activate normally closed (N.C.) relay at LSA limit setpoint, if LSA position configured.
	S3 ON, Activate normally closed (N.C.) relay when any ESD is active.

1.26 User Relay #2 Application



S1,S2,S3,S5 ON, Select User Relay#2 setup mode.
Select user relay#1 function by setting SW1 switches as shown below.



All SW1 switches OFF, Direct control of N.O. relay from network master. Factory default.



S1 ON, Activate normally open (N.O.) relay when Selector Switch in Remote position.

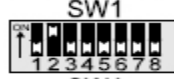

S2 ON, Activate normally open (N.O.) relay when Selector Switch in Local position.



S1,S2 ON, Activate normally open (N.O.) relay at LSB limit setpoint, if LSB position configured.



S3 ON, Activate normally open (N.O.) relay when any ESD is active.



S1,S3 ON, Direct control of normally closed (N.C.) contact from network master.



S2,S3 ON, Activate normally closed (N.C.) relay when Selector Switch in Remote position.



S1,S2,S3 ON, Activate normally closed (N.C.) relay when Selector Switch in Local position.



S4 ON, Activate normally closed (N.C.) relay at LSB limit setpoint, if LSB position configured.



S3 ON, Activate normally closed (N.C.) relay when any ESD is active.

NOTE:

User Relay #1 and User Relay #2 are non-latching SPST type. When power to the actuator is lost, both relays are de-energized and the contacts will open. Do not apply these relays to critical control applications where closed contacts are required during loss of power.

1.27 LSA Position Setpoint

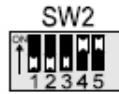

S4,5 ON, Select LSA position setup mode.
Select LSA position by setting SW1 switches as shown on Page 7 .
Range = 0 to 100%
Resolution = 1%
Default = 0 (LSA disabled)

Example: Set LSA position to 30%

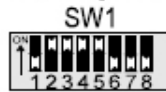

Locate the DIP switch pattern for 30 on Page 7 .

1.28 LSB Position Setpoint



S2,5 ON, Select LSA position setup mode.
Select LSB position by setting SW1 switches as shown on Page 7 .
Range = 0 to 100%
Resolution = 1%
Default = 0 (LSB disabled)

Example: Set LSB position to 60%



Locate the DIP switch pattern for 60 on Page 7 .

1.29 Anti-water Hammer

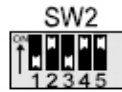

S2,4,5 ON, Select anti-water hammer setup mode.

Select anti-water hammer position by setting SW1 switches as shown on Page 7. This is the position that anti-water hammer is activated while the valve is closing.

Range = 0 to 100%

Resolution = 1%

Default = 0 (Anti-water hammer disabled)

Example: Set Anti-water hammer position to 10%

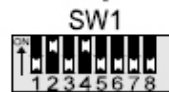

Locate the DIP switch pattern for 10 on Page 7.

1.30 Opening Duty Cycle ON Timer

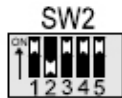

S1,3,4,5 ON, Select opening duty cycle ON timer.

Select opening ON time by setting SW1 switches.

Range = 0 to 65 Seconds,

Resolution = 1 Second,

Default = 0 (Timer disabled)

Example: Set opening ON timer to 6 seconds.



Locate the DIP switch pattern for 6 on Page 7.

1.31 Opening Duty Cycle OFF Timer

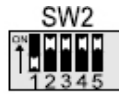

S2,3,4,5 ON, Select opening duty cycle OFF timer.
Select opening OFF time by setting SW1 switches.
Range = 0 to 65 Seconds.
Resolution = 1 Second.
Default = 0 (Timer disabled)

Example: Set opening OFF timer to 9 seconds.



Locate the DIP switch pattern for 9
on Page 7 .

1.32 Closing Duty Cycle ON Timer

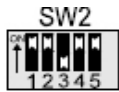

S1,2,4,5 ON, Select closing duty cycle ON timer.
Select closing ON time by setting SW1 switches.
Range = 0 to 65 Seconds.
Resolution = 1 Second.
Default = 0 (Timer disabled)

Example: Set closing ON timer to 6 seconds.



Locate the DIP switch pattern for 6
on Page 7 .

1.33 Closing Duty Cycle OFF Timer

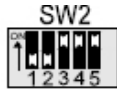

S3,4,5 ON, Select closing duty cycle OFF timer.

Select closing OFF time by setting SW1 switches.

Range = 0 to 65 Seconds.
Resolution = 1 Second.
Default = 0 (Timer disabled)

Example: Set closing OFF timer to 9 seconds.



Locate the DIP switch pattern for 9 on Page 7.

NOTE:

Duty cycle timers are active only when selector switch is in REMOTE position. Opening and closing speed of the valve may be adjusted (slowed) by enabling the opening or closing duty cycle timers. Duty cycle timers are available only with a solid-state or VFD starter. Anti-water hammer duty cycle is fixed at 50% duty with one second ON time and one second OFF time for SSR and VFD starters and two seconds ON time and two seconds OFF time for electro-mechanical starter. When activated, the Anti-water hammer function overrides the closing duty cycle timer. If duty cycle or Anti-water hammer functions are used in any Anti water hammer scheme, EIM must be advised of system parameters and conditions.

1.34 Write Protect

Prevent configuration changes through network CAM connection when write protect is enabled. Requirement for Foundation Fieldbus and Hart. Modbus communication will not be affected. Register 12 Bit 5 is to be defined as Write Protect.

To Enable Select Write Protect:

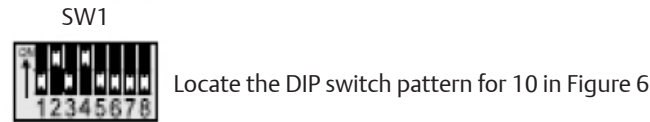
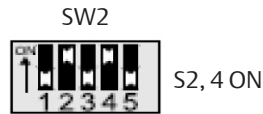

To Disable Write Protect:

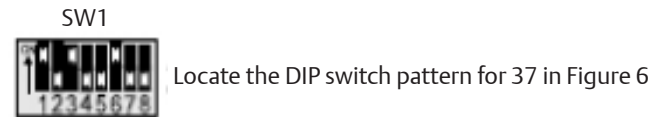
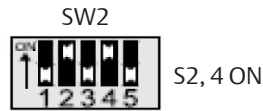

1.35 Setpoint Tracking

To Enable Setpoint Tracking:

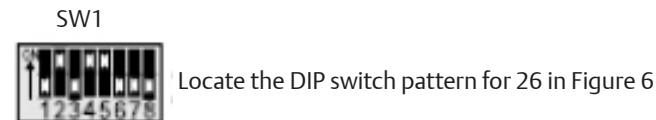
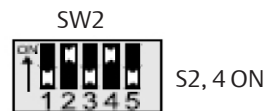

To Disable Setpoint Tracking:

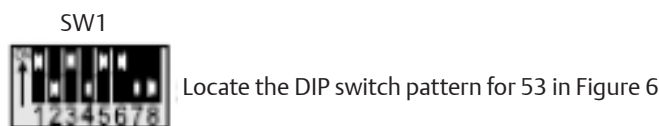
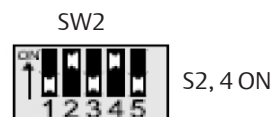

Section 2: Modbus Memory Map Reference

2.1 Modbus Function Codes

	Host beginning register
01 Read Coil Status	00001
02 Read Input Status	10001
03 Read Holding Register	40001
04 Read Input Register	30001
05 Force Single Coil	00001
06 Preset Single Register	40001
07 Read Exception Status	
08 Loopback Diagnostic Test	
15 Force Multiple Coils	00001
16 Preset Multiple Registers	40001
17 Report Slave I.D.	

NOTE:

All registers are zero based. Add one to inputs, coils or holding registers when configuring host database. See host beginning registers above.

2.2 Input Register Map

(Use function code 04)

- 00 Inputs 0-15 (Live discrete inputs)
- 01 Inputs 16-31 (Standard valve status)
- 02 Inputs 32-47 (DCM320 valve status)
- 03 Inputs 48-63 (Specific to DCM320B)

2.3 Input Register 03 (DCM320B only)

- 48 DCM is in Setup Mode
- 49 AIN1 Signal fault
- 50 AIN2 Signal fault
- 51 AIN3 Signal fault
- 52 Software triggered ESD active
- 53-63 Reserved inputs (always zero)

2.4 Discrete Input Map

(Inputs 0 through 15 are hardware inputs)

(use function code 02)

- | | |
|---|--|
| 00 Open limit switch (LSO) | 27 Phase monitor alarm |
| 01 Close limit switch (LSC) | 28 Local ESD alarm |
| 02 Contactor Aux. open contact | 29 Actuator fail alarm |
| 03 Contactor Aux. close contact | 30 No input (always zero) |
| 04 Selector switch Local/Manual | 31 Unit alarm (above alarms OR'ed) |
| 05 Selector switch Remote/Auto | 32 Open limit switch (LSO) |
| 06 Open torque switch (TSO) | 33 Close limit switch (LSC) |
| 07 Close torque switch (TSC) | 34 Stopped (valve stopped in mid travel) |
| 08 Power monitor alarm | 35 Opening (valve moving open) |
| 09 Motor thermal overload | 36 Closing (valve moving close) |
| 10 Phase monitor | 37 Valve stall alarm (valve not moving) |
| 11 Local ESD alarm | 38 Selector switch in Local/Manual |
| 12 Aux. alarm input (VFD fault) | 39 Unit alarm (alarms OR'ed) |
| 13 User discrete input #1 | 40 Motor thermal overload alarm |
| 14 User discrete input #2 | 41 Power monitor alarm |
| 15 Reserved | 42 Primary network alarm |
| 16 Open limit switch (LSO) | 43 Secondary network alarm |
| 17 Close limit switch (LSC) | 44 Open torque alarm (TSO) |
| 18 Opening (valve moving open) | 45 Close torque alarm (TSC) |
| 19 Closing (valve moving close) | 46 Local ESD input alarm |
| 20 Selector switch Local/Manual | 47 Phase monitor alarm |
| 21 Selector switch Remote/Auto | 48 RESERVED |
| 22 Open torque switch (TSO) | 49 Torque out of range |
| 23 Close torque switch (TSC) | 50 AIN1 out of range |
| 24 Valve stall alarm (valve not moving) | 51 AIN2 out of range |
| 25 Power monitor alarm | 52 ESD active alarm |
| 26 Motor thermal overload alarm | 53 EEPROM active config |

2.5 Coil Map

(Coils 0 through 7 are hardware outputs)

(use function code 01, 05 and 15)

00	Close motor starter output	43	Enable Stop on ESD with ESD relay
01	Open motor starter output	44	Enable ESD trigger from host
02	Solid-state relay NFC speed control	45	Enable ESD trigger on local ESD input
03	ESD/Monitor relay output	46	Enable ESD trigger from loss of com.
04	User relay #1/Override relay	47	Configuration conflict error detected
05	User relay #2	48	Select AIN1 as setpoint source
06	Primary network channel 1 enable	49	Select AIN2 as setpoint source
07	Secondary network channel 2 enable	50	Select AIN3 as setpoint source
08	Host OPEN valve command	51	Move to Default on AIN1 fault
09	Host STOP command	52	Move to Default on AIN2 fault
10	Host CLOSE valve command	53	Move to Default on AIN3 fault
11	Host ESD command	54	reserved
12	Enable normal modulating mode	55	Enable setpoint tracking
13	reserved	56	reserved
14	Enable VFD starter control mode	57	Select N.C. contacts for Relay #1
15	Enable pulse control mode	58	Enable Relay #1 as Override on ESD
16	Open limit switch status (LSO)	59	Activate Relay #1 in Remote/Auto
17	Close limit switch status (LSC)	60	Activate Relay #1 in Local/Manual
18	Opening status (valve moving open)	61	Activate Relay #1 at LSA setpoint
19	Closing status (valve moving close)	62	Select N.C. contacts for Relay #2
20	Selector switch Local/Manual	63	Enable Relay #2 as Override on ESD
21	Selector switch Remote/Auto	64	Activate Relay #2 in Remote/Auto
22	Open torque alarm (TSO)	65	Activate Relay #2 in Local/Manual
23	Close torque alarm (TSC)	66	Activate Relay #2 at LSB setpoint
24	Valve stall alarm (valve not moving)	67	Set primary network to odd parity
25	Power monitor alarm	68	Set primary network to even parity
26	Motor overload alarm (Motor thermal)	69	Set secondary net to odd parity
27	Phase monitor alarm	70	Set secondary net to even parity
28	Local ESD alarm	71	Enable primary network alarm
29	Actuator fail alarm	72	Enable secondary network alarm
30	reserved for host (always zero)	73	reserved
31	Unit alarm (all alarms OR'ed)	74	reserved
32	Enable torque seat mode	75	Enable MRTU operating mode
33	Enable logjam retry mode	76	Enable torque backseat
34	Enable 4-20mA feedback at A0#1	77	Save torque profile to EEPROM
35	Enable monitor relay, else ESD relay	78	CPU has reset
36	Enable passcode protection	79	Load factory default configuration
37	Enable solid-state starter control mode	80	Write protect
38	reserved	81	Setup mode
39	Enable Close on ESD w/o ESD relay	100	Host OPEN valve command
40	Enable Open on ESD w/o ESD relay	101	Host CLOSE valve command
41	Enable Close on ESD with ESD relay	102	Host STOP command
42	Enable Open on ESD with ESD relay	103	Host ESD command

2.6 Holding Register Map

(RO = Read Only RW = Read/Write)

(Use function 03, 06 and 16)

00	RW	Coils 0-15	42	RW	Passcode char 1(LSB) & 2(MSB)
01	RO	Coils 16-31	43	RW	Passcode char 3(LSB) & 4(MSB)
02	RW	Coils 32-47	44	RO	Firmware version
03	RW	Coils 48-63	45	RO	Compatibility number
04	RW	Coils 64-79	46		reserved
05	RO	Inputs 0-15	47		reserved
06	RO	Inputs 16-31	48	RO	Torque@ 10% valve position
07	RO	Valve Position 1.0% increments	49	RO	Torque@ 20% valve position
08	RO	Valve Status inputs 32-47	50	RO	Torque@ 30% valve position
09	RO	Valve Status inputs 16-31	51	RO	Torque@ 40% valve position
10	RW	Analog Output (0-4095)	52	RO	Torque@ 50% valve position
11	RW	Valve Position Setpoint (0-4095)	53	RO	Torque@ 60% valve position
12	RO	Inputs 48-63	54	RO	Torque@ 70% valve position
13	RO	Valve Position (0.1% increments)	55	RO	Torque@ 80% valve position
14	RO	Position Analog Input (0-4095)	56	RO	Torque@ 90% valve position
15	RO	Torque Analog Input (0-4095)	57	RO	Torque profile @ 10%
16	RO	User Analog Input #1 (0-4095)	58	RO	Torque profile @ 20%
17	RO	User Analog Input #2 (0-4095)	59	RO	Torque profile @ 30%
18	RW	Water Hammer setpoint (1-20%)	60	RO	Torque profile @ 40%
19	RW	Modulation delay (0.1-25.5 sec)	61	RO	Torque profile @ 50%
20	RW	ESD Delay timer (0-65.5 sec)	62	RO	Torque profile @ 60%
21	RW	Position Bandwidth (0.1-5.0%)	63	RO	Torque profile @ 70%
22	RW	Speed Bandwidth (0.5-10%)	64	RO	Torque profile @ 80%
23	RW	Default Position Setpoint (0-4095)	65	RO	Torque profile @ 90%
24	RW	Torque AIN Zero offset, raw cnts	66	RW	Accumulator #1 (User Input #1)
25	RW	Torque AIN Span, raw AID counts	67	RW	Accumulator #1 (User Input #2)
26	RW	User AIN1 Zero offset, raw counts	68	RW	Lost COM ESD delay (mS)
27	RW	User AIN1 Span, raw AID counts	69	RW	Stall time delay (mS)
28	RW	User AIN2 Zero offset, raw counts	70	RW	RW Valve Travel Time/1% (mS)
29	RW	User AIN2 Span, raw AID counts	100	RO	RO Unit I.D.
30	RW	A0#1 Zero offset, raw counts			
31	RW	A0#1 Span, raw D/A counts			
32	RW	LSA Setpoint (0-4095)			
33	RW	LSB Setpoint (0-4095)			
34	RW	Close ON duty cycle (0-65.5 sec)			
35	RW	Close OFF duty cycle (0-65.5 sec)			
36	RW	Open ON duty cycle (0-65.5 sec)			
37	RW	Open OFF duty cycle (0-65.5 sec)			
38	RW	Primary network baudrate			
39	RW	Primary network response delay			
40	RW	Secondary network baudrate			
41	RW	Secondary network response delay			

NOTE:

- 1) Unless otherwise specified, analog I/O is unsigned integer in range of 0-4095.
- 2) All time parameters are in mS.
- 3) Torque readings are raw AID counts.
- 4) Torque profile values are read from EEPROM.
- 5) Do not write to reserved registers.

Section 3: Network Installation Guide

Step 1: Plan the network topology

Before connecting actuators, the entire network layout should be planned. Select desired network topology from Figures 2 and 3 on page 5. Topologies may be bus or E>Net or a combination of bus and E>Net. All networks may be redundant or ring or redundant rings. Limit the number of parallel connected bus units to 15 between E>Net units. Network planning should include node addressing, wire routing, terminations, and grounding.

Step 2: Select network cable

Ensure correct cable is being used. Networks require twisted pair and shielded cable with a characteristic impedance between 50 and 120 Ohms. Capacitance between conductors must be less than 30pF/ft (98 pF/m); 10-15pF/ft is ideal. Shielding may be aluminum foil with drain wire. Only cables with stranded conductors are recommended. Insulating and outer jacket materials must be selected for the application environment. Following are acceptable Belden or equivalent cables for most network applications.

24AWG 9841, 12.8pF/ft	22AWG 8761, 24pF/ft	20AWG 8762, 27pF/ft	18AWG 8760, 24pF/ft	16AWG 8719, 23pF/ft	14AWG 8720, 24pF/ft
8162, 9729, and 9842 are 24AWG, 2-pair cables with <13pF/ft					

Step 3: Route cable away from electrical interference

Network cables should enter the electrical enclosure at the bottom or lowest point near the transformer end. Route cable around the transformer end, normally in a counter clockwise direction to the top side of the TBM. Never install network cable in the same conduit with power conductors. Never route network cable through the high voltage contactor area. The cable should never lie across the TBM or hinder the protective cover of the TBM. Always use the shortest distance and keep excess cable to a minimum; 6" typical.

Step 4: Observe polarity and network grounding

Each network connection is polarized + and - on wiring diagrams. Always use consistency in wiring and the use of wire colors to track polarity. The cable shield or drain wire must be connected to the designated (SH) terminal at each port of each actuator. The shield must be connected to earth ground at only one point. Some networks may require a jumper between shield connections (Terminals 22 and 23) of each actuator to carry the shield through the network. The shield connection of each actuator is isolated from earth. Do not allow the shield to touch circuits on the TBM or the metal enclosure. Use plastic electrical tape or heat shrink tubing to isolate the shield or drain wire.

Step 5: Wire preparation and connections

Screw terminals of the TBM have wire clamps that accept wires without terminals but may be applied if desired. Strip insulation back 3/8" when connecting directly to the TBM screw terminals. Do not allow wire clippings to fall on the TBM or into the actuator enclosure. Protect conductors and the shield or drain wire to prevent contact with the TBM. Use plastic electrical tape or heat shrink tubing to prevent bare conductors from contacting other circuits or earth ground.

Step 6: Wire preparation and connections

Use DCMLink or Controlinc Pocket Technician to test the network prior to connecting to a host or network master. The DCMLink is a Windows application that will run on a laptop using an RS232 to RS485 adapter or the Network Interface Unit (NIU) for connecting to the network. After all actuators are verified to operate in Local mode, test each actuator to verify all network connections and each actuator operates via the network in Remote mode.

Section 4: System Startup Guide

Step 1: Set position and torque limit switches

Set open and close position and torque switches while operating valve full open and close with local push buttons. Refer to Manual E796 for limit switch setting instructions.

Step 2: Set DIP switches

Set address DIP switches to unique address as shown in the first section of this guide. Refer to Figure 5 on page 5 for location of DIP switches. Refer to network station address switch settings on pages 6 and 7. Also remember to check baud rate of each actuator to ensure it matches the host system.

Step 3: Check network wiring

Check polarity of each network connection per wiring connections shown in Figure 3 of this guide. Ensure shield is connected at each actuator and is earth grounded at only one point. Refer to page 26 for additional instructions on network installation.

Step 4: Check network terminations

Bus networks require termination resistance and bias at each end of the network. Remove termination and bias on all modules except the last, most distant unit at the end of the network. Always leave termination and bias on every unit when using E>Net. See Figure 4 for location of DIP switches and jumpers for termination and bias selection. Verify quiescent line bias is 250mV minimum during no communication activity.

Step 5: Test network

Use DCMLink software to test each actuator. Ensure each station address is tested and verify received data. View communication signals with oscilloscope to ensure good signal strength and clean waveforms. Repeat test for each actuator on redundant network if installed.

Step 6: Verify network master configuration

If using the Controlinc Network Master, refer to the User Manual supplied with the system for setup details. If direct connecting to your DCS, SCADA, or PLC system, refer to the manufacturer's supplied documentation. Verify network baud rate and parity match the settings of the actuators. Verify the master is configured for the total number of actuators and database matches network address assignments per actuator location on network. Take system out of test or diagnostic mode when finished.

Step 7: Test host interface

If using the Controlinc Network Master, use Modbus host test software supplied with the system to test slave port(s) of the network master. If direct connect to other host equipment, use software supplied with that equipment to test actuators. Verify database for each node and I/O point by tag name and mapping of each point to operator's screen. Operate each valve open and close or to setpoint. Test each auxilliary I/O point.

Tools:

- 1) Speed handle or 3/8" battery drill with 1/2" thin wall socket
- 2) Common screwdriver
- 3) Multimeter (VOM)
- 4) Portable oscilloscope (optional)
- 5) Laptop computer with Windows
- 6) DCMLink w/ RS485 adapter
- 7) Other system test software supplied with host system
- 8) Programming cables
- 9) 4-20mA calibrator for analog I/O

Section 5: Optional Phase Monitor

If your actuator contains the optional phase monitor, then this section applies.

The phase monitor module shown in Figure 7 is mounted on the back side of the DCM 320B module facing the motor starter.

Figure 7

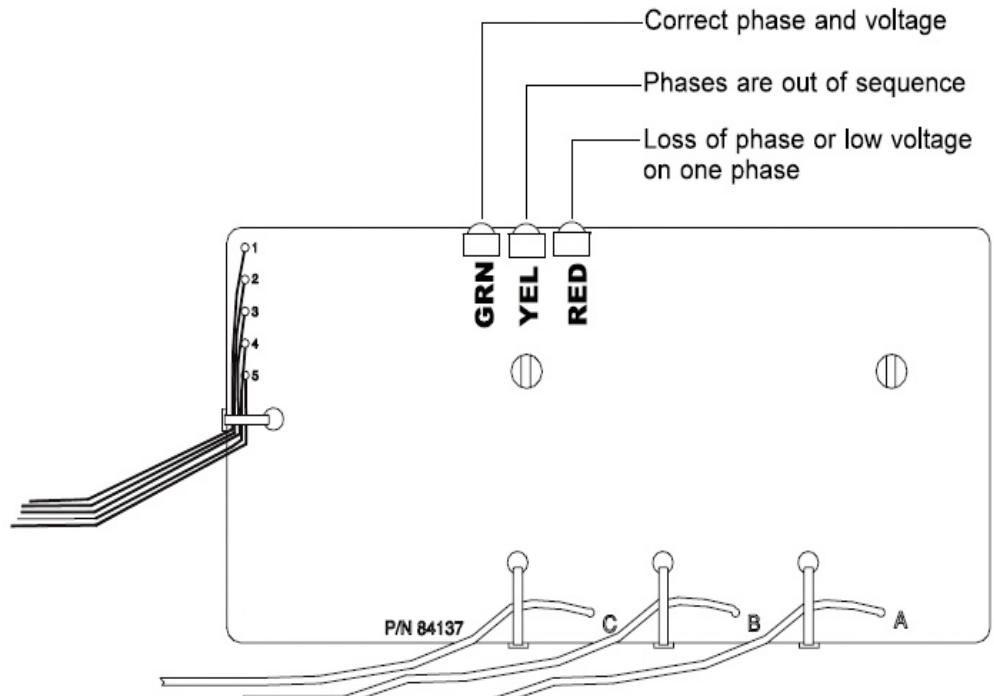

NOTE:

We advise using phase sentry mode rather than phase correction.

Phase sentry mode will cause the actuator to shut down if phases are out of sequence for proper electric motor rotation or a loss of phase is detected. Phase correction mode will cause the actuator to correct the phase sequence and continue to operate when phases are out of sequence. Either mode will cause the actuator to shut down if a loss of phase (single-phasing) is detected.

To select modes, do the following:

- 1) Remove TBM 320A termination panel.
- 2) Locate 3-pin jumper P9 on bottom of board marked PC and PS.
 - PC means Phase Correction.
 - PS means Phase Sentry.
- 3) Move the shorting strap to the desired mode selection (PC or PS).

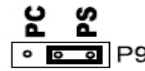

Section 6: Alarm Definitions and Troubleshooting Guide

Table 1.

Alarm	Definition / explanation	Actions to be taken
Open Torque Alarm	Actuator exceeded open torque limit setting	Check torque switch dial setting for open torque limit and proper orientation of Torque Switch Rotor Assembly Cams
Close Torque Alarm	Actuator exceeded close torque limit setting	Check torque switch dial setting for close torque limit and proper orientation of Torque Switch Rotor Assembly Cams
Valve Stall Alarm	No actuator movement or position feedback after 8 seconds upon a commanded movement	<ul style="list-style-type: none"> Check wire leads for potentiometer connection to P2 of DCM 320B module. RED Lead to Bottom (Pin 3) Check for proper potentiometer movement Check for complete control circuit for commanded action Check for correct Selector Switch position Verify DCM320B is not in configuration mode
Power Monitor Alarm	Indicates lost control voltage, or lost power, or lost phas (if supplied with a Phase Sentry Module)	<ul style="list-style-type: none"> Check motor thermals Check primary & secondary fuses Verify primary power is present
Motor Thermal Overload	Protects motor windings from increased internal temperature rise when under increased load or duty cycle.	Check for open circuit between terminals 1 and X0 if motor thermal leads are connected
Phase Monitor Alarm	Indicates the condition of the three-phase primary power supply. Can detect lost phase or incorrect phase.	<ul style="list-style-type: none"> Check incoming primary power source. Check transformer Check Contactor to see the right power source are present
Hardwired - ESD Alarm	External hardwired circuit is activated on an open circuit. Local ESD overrides other commands based on configuration to Open, Close or Stay Put when there is Emergency Shut Down (ESD) trigger or loose/missing ESD Inhibit Jumpers on the Terminal Board Terminals.	Check if TBM jumpers on terminal 26 to 27 and 28 to 29 are present. If connected, check external ESD trigger circuit for closed connection.
Actuator Fail Alarm	Indicates Configuration Error or control circuit connection is when a configuration parameter out of range	Check actuator configuration parameter and make they are correct to their specifications.
Com No-Response Alarm	Indicates there is no communication from the actuator to the host via Modbus RS485 Network.	<ul style="list-style-type: none"> Check network connection, polarity, parity, baud rate, and modbus address Check for active DCM320B (LEDs D1-D5)
Unit Alarm	Universal Alarm indicating actuator has experienced an event; or any of the control or configuration alarms noted above except Lost Communications.	<ul style="list-style-type: none"> Check that DCM320B Configuration Dipswitches are in the Run Mode Check for other alarm conditions and resolve as necessary.

World Area Configuration Centers (WACC) offer sales support, service, inventory and commissioning to our global customers. Choose the WACC or sales office nearest you:

NORTH & SOUTH AMERICA

19200 Northwest Freeway
Houston TX 77065
USA
T +1 281 477 4100

Av. Hollingsworth
325 Iporanga Sorocaba
SP 18087-105
Brazil
T +55 15 3413 8888

ASIA PACIFIC

No. 9 Gul Road
#01-02 Singapore 629361
T +65 6777 8211

No. 1 Lai Yuan Road
Wuqing Development Area
Tianjin 301700
P. R. China
T +86 22 8212 3300

MIDDLE EAST & AFRICA

P. O. Box 17033
Jebel Ali Free Zone
Dubai
T +971 4 811 8100

P. O. Box 10305
Jubail 31961
Saudi Arabia
T +966 3 340 8650

24 Angus Crescent
Longmeadow Business Estate East
P.O. Box 6908 Greenstone
1616 Modderfontein Extension 5
South Africa
T +27 11 451 3700

EUROPE

Holland Fásor 6
Székesfehérvár 8000
Hungary
T +36 22 53 09 50

Strada Biffi 165
29017 Fiorenzuola d'Arda (PC)
Italy
T +39 0523 944 411

For complete list of sales and manufacturing sites, please visit www.emerson.com/actuationtechnologieslocations or contact us at info.actuationtechnologies@emerson.com

www.emerson.com

©2019 Emerson. All rights reserved.

The Emerson logo is a trademark and service mark of Emerson Electric Co. All other marks are property of their respective owners.

The contents of this publication are presented for information purposes only, and while every effort has been made to ensure their accuracy, they are not to be construed as warranties or guarantees, express or implied, regarding the products or services described herein or their use or applicability. All sales are governed by our terms and conditions, which are available on request. We reserve the right to modify or improve the designs or specifications of our products at any time without notice.

