

Operating Manual for Bettis RTS CM Series

Compact Multi-Turn Electric Actuator



Table of Contents

Section 1: Introduction

Section 2: General

2.1	Actuator Overview	2
2.2	Serial Number and Type Label	2
2.3	Operating Mode.....	3
2.4	Protection Class	3
2.5	Mounting Position.....	4
2.6	Direction of Rotation.....	5
2.7	Protection Devices	6
2.8	Ambient Temperature	6
2.9	Delivery Condition of the Actuators	6
2.10	Information Notice (Tag)	7

Section 3: Packaging, Transport and Storage

3.1	General	8
3.2	Storage	8
3.3	Long-term Storage.....	9

Section 4: Installation Instructions

4.1	Mechanical Connection.....	11
4.2	Mounting Position of the Operating Unit.....	12
4.3	Electrical Connection	13

Section 5: Commissioning

5.1	General	16
5.2	Manual Operation	16
5.3	Mechanical Default Settings and Preparation	16
5.4	End Limit Setting.....	16
5.5	Final Step	23

Section 6: Control Unit

6.1	Operating Unit	24
6.2	Display Elements.....	25
6.3	Operation	27

Section 7: Parameter Menu

7.1	Parameter Group: End Limit	36
7.2	Parameter Group: Torque	38
7.3	Parameter Group: Speed	39
7.4	Parameter Group: Ramp (optional).....	39
7.5	Parameter Group: Control	40
7.6	Parameter Group: Password	40
7.7	Parameter Group: Position	41
7.8	Parameter Group: Binary Inputs	41
7.9	Parameter Group: Binary Outputs	44
7.10	Parameter Group: Position Output (optional)	47
7.11	Parameter Group: Step Mode	49
7.12	Parameter Group: Positioner (option).....	51
7.13	Parameter Group: PID Controller (optional).....	53
7.14	Parameter Group: Profibus-DP (option)	55
7.15	Parameter Group: DeviceNet (option)	55
7.16	Parameter Group: Characteristic Curves (optional).....	56
7.17	Parameter Group: Identification (option).....	57
7.18	Parameter Group: System Parameters (locked)	57
7.19	Parameter Group: Miscellaneous	58

Section 8: Status Area

8.1	Status.....	59
8.2	History	62

Section 9: Infrared Connection

Section 10: Bluetooth Link

Section 11: Maintenance

Section 12: Troubleshooting

12.1	Error List.....	67
------	-----------------	----

Section 13: Fuses

Section 14: Lubricant Recommendation and Requirements

14.1 Main Body: -25 to +60°C	70
14.2 Output Type A and Spindle Drives (Linear Actuators) -40 to +85°C	70
14.3 Basic Lubricant Service Interval	70

Section 15: Training

Section 16: Technical Data and Certifications

16.1 Binary Outputs	73
16.2 Binary Inputs	74
16.3 Analog Inputs	78
16.4 Analog Output	78
16.5 Auxiliary Voltage Input and Output	80
16.6 Connections	81
16.7 Miscellaneous	81

Section 1: Introduction

These operating instructions apply to Bettis RTS CM Series of Compact Multi-Turn actuators.

The scope of application covers the operation of industrial valves, e.g., globe valves, gate valves, butterfly valves and ball valves. For other applications please consult with the factory.

The manufacturer shall not be liable for incorrect use and possible damage arising thereof. The risk shall be borne solely by the user.

Using the unit as intended also entails the observance of these operating instructions.

⚠ CAUTION: OBSERVE HAZARDOUS VOLTAGE LEVEL

When operating electrical equipment, certain parts inevitably carry hazardous voltage levels. Work on the electrical system or equipment must be carried out only in accordance with electrical regulations by a qualified electrician himself or by specially instructed personnel under the control and supervision of a qualified electrician.

Maintenance instructions must be observed as otherwise the safe operation of the actuator cannot be guaranteed.

Failure to follow the warning information may result in serious bodily injury or property damage. Qualified personnel must be thoroughly familiar with all warnings contained in this operating manual.

Proper transport, storage, installation, assembly and careful commissioning are essential to proper and safe operation.

⚠ WARNING: ALWAYS REFER TO STANDARDS

When working in potentially explosive areas, observe the European Standards EN 60079-14 "Electrical Installations in Hazardous Areas" and EN 60079-17 "Inspection and Maintenance of Electrical Installations in Hazardous Areas".

Maintenance work on open actuators may only be conducted if these are de-energized. Reconnection during maintenance is strictly prohibited.

Section 2: General

The Bettis RTS Series Compact Multi-Turn actuator is a rotary actuator with integrated controller for valve operation. The integral multi-turn sensor allows setting the travel limits without opening the housing.

2.1 Actuator Overview

Figure 1 The Bettis RTS Series Compact Multi-Turn Actuator

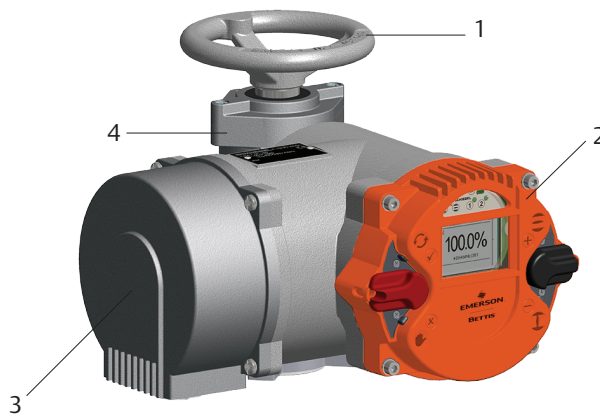

Parts Overview:

1. Handwheel
2. Control unit (Operating unit)
3. Connection compartment
4. Gear component

2.2 Serial Number and Type Label

Each actuator of the RTS Compact Multi-Turn CM series carries a serial number. The serial number begins with the year and that can be read from the type label (see Figure 2) of the actuator (the type label is located next to the handwheel – see Figure 3).

Using this serial number, Emerson can uniquely identify the actuator (type, size, design, options, technical data and test report).

Figure 2 Bettis RTS Tag and Serial Number





Type: CM-32A-100HB		
No.: 18113E04203		1026
Close: 32Nm		2018
Open: 32Nm		
<100	Tamb-40..+60°C	
2,5-70	-  II 2 G Ex d e IICT 4 Gb	
IP68	TÜV-A16ATEX0007X	
I _N : 1,47A/230VAC	LC16.13198-1S	
110-240VAC 50/60Hz	 AEx de IIC T4 Gb	
	IECEX LC 17.0003X	
S2-15min	Ex de IIC T4 Gb	
	Class 1 Div 1 & 2 Group A	
19200 Northwest Fwy, Houston, TX 77065		180830/1

Figure 3 Label 1 - Type Label



2.3 Operating Mode

RTS Compact Multi-Turn CM actuators are suitable for open-loop control (S2 operating mode - on/off duty) and closed-loop control (S9 operating mode - modulating duty) according to EN 60034-1.

2.4 Protection Class

RTS Compact Multi-Turn CM actuators come by default with IP68 (EN 50629) protection.

CAUTION: PROTECTION CLASS AND CABLE GLANDS

The protection class specified on the type label is only effective when cable glands also provide the required protection class, the cover of the connection compartment is carefully secured and the mounting position (see Section 2.5) is observed.

We recommend metallic threaded cable glands with a metrical thread. Unused, cable inlets must be closed with stopping plugs. On explosion-proof actuators, cable glands with protection class **EEx e according EN60079-7** must be used. After removing covers for assembly purposes or adjustment work, take special care upon reassembly so that seals are not damaged and remain properly fastened. Improper assembly may lead to water ingress and to failures of the actuator.

NOTE:

The cover of the control unit - the Operating unit - (see Figure 1) must not be opened.

Allow a certain sag in the connector cables before reaching the screwed cable glands so that water can drip off from the connector cables without running to the screwed cable glands. As a result, forces acting on the screwed cable glands are also reduced. (see Section 2.5)

2.5 Mounting Position

Generally, the installation position is irrelevant. However, based on practical experience, it is advisable to consider the following for outdoors use or in splash zones:

- Mount actuators with cable inlet facing downwards
- Ensure that sufficient cable slack is available

2.6 Direction of Rotation

Unless specifically ordered otherwise, the standard direction is (see Figure 4 and Figure 5):

- **Right turning (clockwise) = CLOSING**
- **Left turning (counter clockwise) = OPENING**

Figure 4 Clockwise = Close

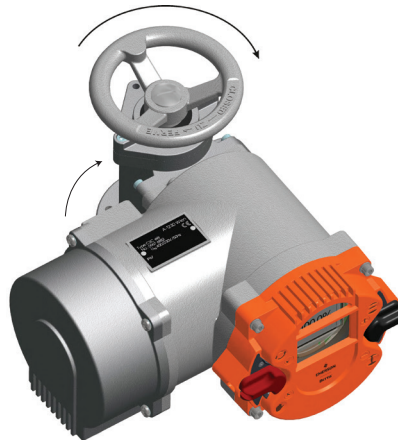
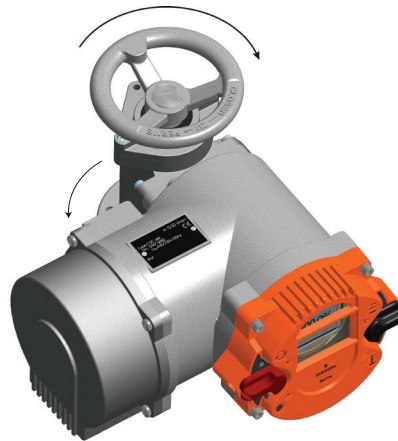

Figure 5 Counterclockwise = Close



⚠ CAUTION: OBSERVE DIRECTION OF ROTATION

All specifications in this operating manual refer to the standard direction of rotation.

2.7 Protection Devices

2.7.1 Torque

RTS Compact Multi-Turn actuators provide electronic torque monitoring. The switch off torque can be modified in the menu of the controller for each direction separately. By default, switch off torque is set to the ordered value. If no torque was specified with the order, the actuator is supplied from the factory with the maximum configurable torque.

For more information, (see Section 7.2).

2.7.2 Motor Temperature

All RTS Compact Multi-Turn CM actuators are normally equipped with motor winding temperature sensors, which protect the motor against excessive winding temperature.

The display will show the corresponding error upon exceeding the permissible motor temperature (see Section 12.1).

2.7.3 Input fuse, thermal fuse

The frequency inverter is protected by an input fuse and the explosion proof version by a thermal fuse. If one of the fuses releases, a serious defect occurs and the frequency inverter must be replaced.

2.8 Ambient Temperature

Unless otherwise specified upon ordering, the following operating temperatures apply:

- On/off duty (open-loop control) -25 to +60°C
- Modulating duty (closed-loop control) -25 to +60°C
- Explosion-proof version -20 to +40°C (acc. EN60079-0)
- Explosion-proof version with extended temperature range -40 to +60°C

CAUTION: OBSERVE OPERATING TEMPERATURE

The maximum operating temperature can also depend on further order-specific components. Please refer to the technical data sheets to confirm the as-delivered product specifications.

2.9 Delivery Condition of the Actuators

For each actuator, an inspection report is generated upon final inspection. In particular, this comprises a full visual inspection, calibration of the torque measurement in connection with an extensive run examination and a functional test of the microcontroller.

These inspections are conducted and documented according to the quality system and can be made available if necessary. The basic setting of the end position must be performed after assembly on the actuator.

⚠ CAUTION: OBSERVE COMMISSIONING INSTRUCTIONS

Commissioning instructions (see Section 5) must be strictly observed. During assembly of the supplied valves at the factory, end positions are set and documented by attaching a label (see Figure 6). During commissioning at the plant, these settings must be verified.

2.10 Information Notice (Tag)

Each actuator is provided with a bilingual tag containing key information, which is attached to the handwheel after final inspection. This tag also shows the internal commission registration number (see Figure 6).

Figure 6 Tag

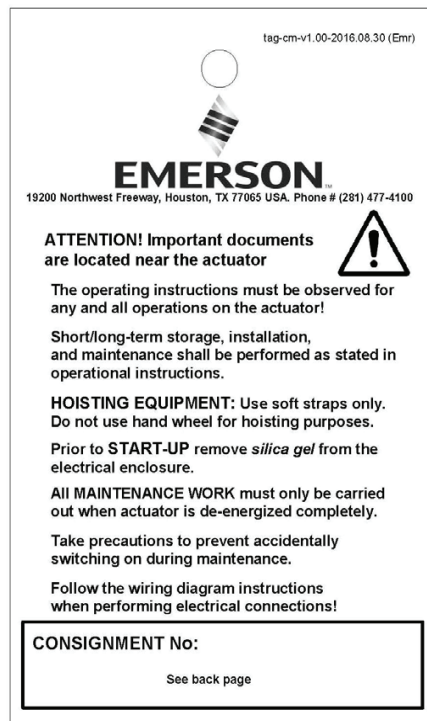

Section 3: Packaging, Transport and Storage

Depending on the order, actuators may be delivered packed or unpacked. Special packaging requirements must be specified when ordering. Please use extreme care when removing or repackaging equipment.

⚠ CAUTION: USE APPROPRIATE LIFTING EQUIPMENT

Use soft straps to hoist the equipment; do not attach straps to the handwheel. If the actuator is mounted on a valve, attach the straps to the valve and not to the actuator.

3.1 General

The connection compartment of RTS Compact Multi-Turn CM actuators contains 5g of factory supplied silica gel.

⚠ CAUTION: REMOVE SILICA GEL

Please remove the silica gel before commissioning the actuator (see Section 5).

3.2 Storage

⚠ CAUTION: OBSERVE PROPER STORAGE

- Store actuators in well-ventilated, dry premises
- Protect against floor dampness by storing actuators on wooden grating, pallets, mesh boxes or shelves
- Protect the actuators against dust and dirt with plastic wrap
- Actuators must be protected against mechanical damage
- The storage temperature must be between -20°C - +40°C

It is not necessary to open the controller of the actuator for servicing batteries or similar operations.

3.3 Long-term Storage

⚠ CAUTION: 6 MONTHS OF STORAGE

If you intend to store the actuator for over 6 months, also follow the instructions below:

- The silica gel in the connection compartment must be replaced after 6 months of storage (from date of delivery)
- After replacing the silica gel, brush the connection cover seal with glycerine. Then, carefully close the connection compartment again
- Coat screw heads and bare spots with neutral grease or long-term corrosion protection
- Repair damaged paintwork arising from transport, improper storage, or mechanical influences
- For explosion-proof actuators, it is not allowed to extensively overpaint the actuator. According to the standard, in order to avoid electrostatic charge, the maximum thickness of the varnish paint is limited to 200 μm
- Every 6 months all measures and precautions for long term storage must be checked for effectiveness and corrosion protection and silica gel renewed
- Failure to follow the above instructions may lead to condensation which can damage to the actuator

Section 4: Installation Instructions

Figure 7 Parts Overview

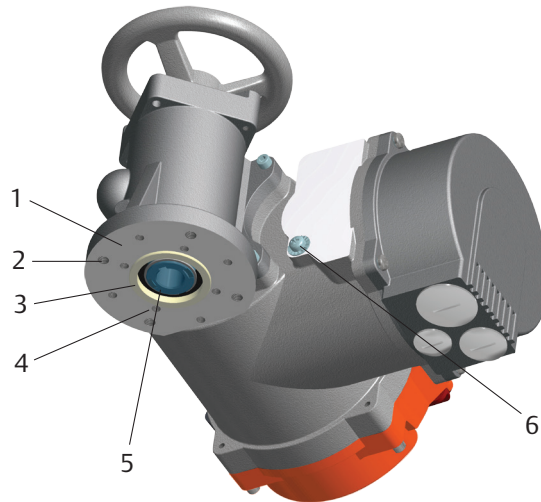

Parts Overview:

1. Mounting flange
2. Bolt pattern G0/F10
3. Centring ring
4. Bore pattern F07
5. Shaft connection
6. Ground connection

NOTE:

Installation work of any kind of actuator may only be performed by qualified personnel.

4.1 Mechanical Connection

See Figure 7.

Check whether the valve flange, actuator flange and valve shaft coincide with the shaft connector of the actuator. For output type "A" (threaded bushing with bore), check ensure the thread of the valve matches the thread of the actuator. In general, proceed as follows:

- Clean the bare parts of the actuator uncoated with corrosion protection
- Thoroughly clean mounting flange of the valve
- In the actuator, properly lubricate the output shaft and the valve of the driven shaft.
- In the "A" version, ensure that the valve bushing is properly lubricated.
- Attach the actuator to the valve or gearbox.
- Tighten fastening screws (torque according to table below).
- By means of the handwheel, check the ease of movement of the actuator-valve connection.

Table 1. Thread Table (1)

Thread	Tightening [Nm] for screws with strength class	
	8.8	A2-70 / A4-70
M6	11	8
M8	25	18
M10	51	36
M12	87	61
M16	214	150
M20	431	294
M30	1489	564

NOTE:

For output type A/Am (unbored/bored threaded bushing), you must sufficiently lubricate both needle bearings in the output after processing and cleaning the spindle nut. For this purpose, use the optional Bettis RTS CM grease lubricant or a grease lubricant according to our recommendation (see Section 14).

4.2 Mounting Position of the Operating Unit

The mounting position of the operating unit can be rotated in 90° steps.

Figure 8 Control System Mounting

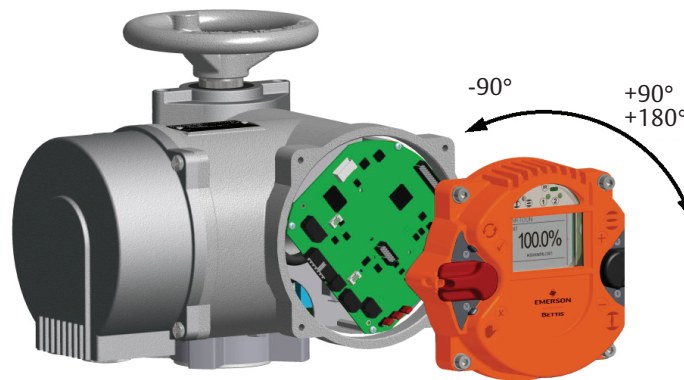

- Disconnect the actuator and control system from the power supply.
- To prevent damage to the electronic components, both the control system and the person have to be earthed.
- Unscrew the bolts for the interface surface and carefully remove the service cover.
- Turn service cover to new position and put back on.
 - Ensure correct position of the O-ring
 - Turn service cover by max. of 180°.
 - Put service cover on carefully so that no cables get wedged in.
- Tighten bolts evenly in a clockwise sequence.

Important

Max torque 5 Nm

4.3 Electrical Connection

⚠ CAUTION: ELECTRICAL CONNECTIONS

Electrical connections may only be carried out by qualified personnel. Please observe all relevant national security requirements, guidelines, and regulations. The equipment should be de-energized before working on electrical connections. As a first step connect the ground screw and confirm the absence of electrostatic discharge during connection.

The line and short circuit protection must be done on the system side.

The ability to unlock the actuator is to be provided for maintenance purposes. For the dimensioning the rated current is to be used (see Technical Data).

Check whether the power supply (voltage, frequency) is consistent with the connection data (see name plate - Figure 2)

The connection of electrical wiring must follow the circuit diagram. This can be found in the appendix of the documentation. The circuit diagram can be ordered from Emerson by specifying the serial number.

When using options, such as a Profibus connection, the relevant guidelines must be followed.

4.3.1 Power Supply Connection

RTS Compact Multi-Turn CM actuators feature an integrated motor controller, i.e. only a connection to the power supply is required. In non explosion-proof actuators, the wiring uses a connector independent from control signals (see Figure 9).

Figure 9 Enclosure Parts

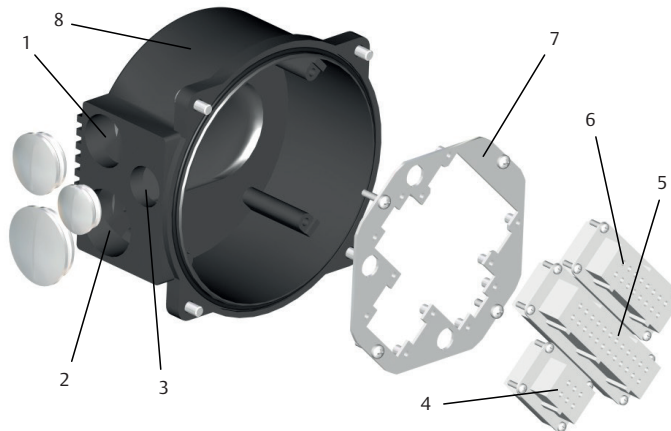

Parts Overview:

1. Metric screw M32x1,5
2. M40x1,5, 3 - M25x1,5
3. M25x1,5
4. Plug insert (for power supply)
5. Plug insert (for control cables)
6. Connector for options
7. Connector Plate
8. Connecting Housing

Explosion-proof actuators or on special request the connection will be made via terminals (see Figure 10).

Figure 10 Bettis RTS Terminal Box

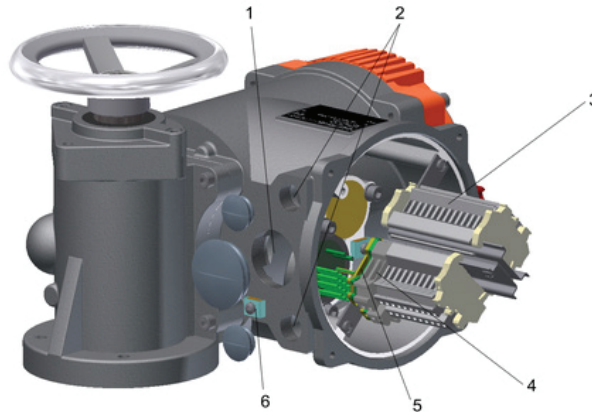

Terminal Box Overview:

1. Metric screw M40x1,5
2. 2 x M20x1,5
3. M25x1,5
4. Terminals for the power supply
5. Terminal for ground connection
6. Outside ground connection

⚠ CAUTION: OBSERVE CORRECT PROCEDURE

If, during outdoor installation, commissioning is not carried out immediately after electrical connection, the power supply must be connected at a minimum to achieve a heating effect. In this case, the silica gel may remain in the connection compartment until commissioning. (see Section 3.3)

Section 5: Commissioning

Before commissioning, please ensure the actuator is correctly assembled and electrically connected. (see Section 4).

⚠ CAUTION: REMOVE SILICA GEL

Remove silica gel from the connection compartment.

5.1 General

⚠ CAUTION: RESET ELECTRIC END POSITIONS

During commissioning and after every disassembly of the actuator, the positions (see Section 5.4) must be reset.

5.2 Manual Operation

The use of a differential gearbox in the handwheel assembly makes mechanical clutching unnecessary during manual operation.

⚠ CAUTION: DO NOT USE CHEATER BARS

Manual operation with mechanical or electromechanical equipment (such as: lever, drilling machine, etc.) is NOT ALLOWED, as this may damage the product.

5.3 Mechanical Default Settings and Preparation

The use of multi-turn sensors makes mechanical settings unnecessary.

⚠ CAUTION: ADJUST TORQUE BEFORE OPERATION

Before the motorized operation of the valve, it is essential to check and adjust torque settings.

5.4 End Limit Setting

A detailed description of the operation of the RTS Compact Multi-Turn CM controller can be found in Section 6.3.

5.4.1 End limit OPEN

Step 1 - Set the selector switch and control switch to the centre position.

Figure 11 Switches in Center Position

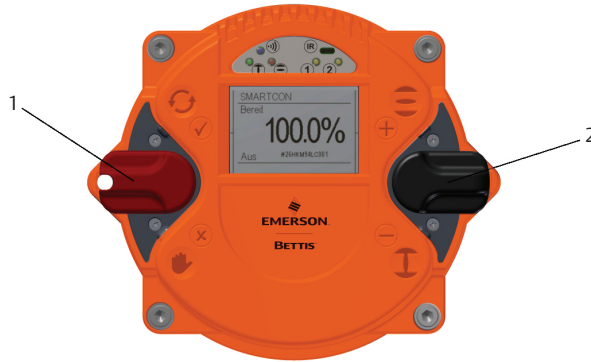

Terminal Box Overview:

1. Selector Switch (Red)
2. Control Switch (Black)

Step 2 - Scroll through the menu with the control switch. Move the control switch towards the first menu item "P 1.1 End limit – Open".

Figure 12 Control Switch End Limit Open

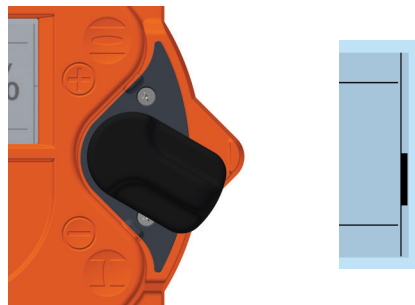
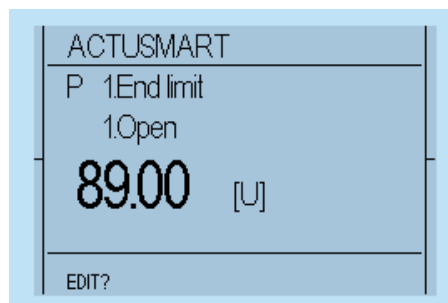

Figure 13 Front Display for End Limit Open



Step 3 - Afterwards, flip up the selector switch slightly and let it snap back to its neutral position. ✓

Figure 14 Selector Switch Setting (1)

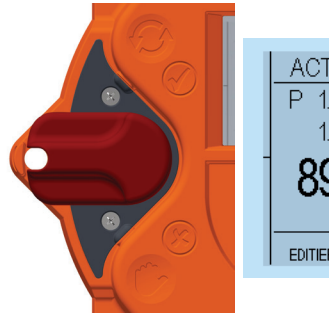

Figure 15 Selector Switch Setting (2)

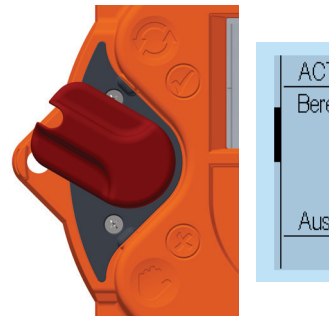
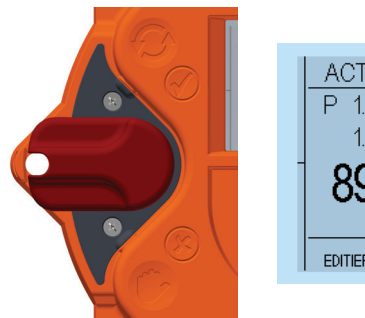

Figure 16 Selector Switch Setting (3)



Step 4 - This changes the bottom line of the display from "EDIT?" to "SAVE?"

Figure 17 Edit and Save

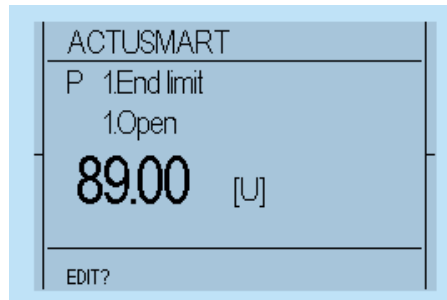
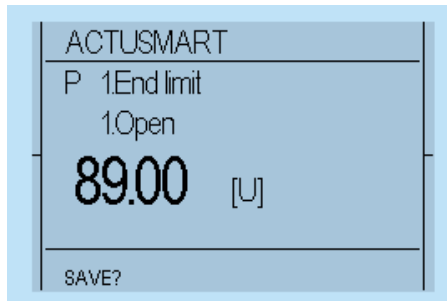

Figure 18 Save Settings



Step 5 - Then, push down the selector switch until it snaps into place. In doing so, the bottom right now on the display will show "TEACHIN" ⊕.

⚠ CAUTION: USE OPERATING SWITCH

Once the display shows "TEACHIN", use the control switch (black switch) to start the motorised operation of the actuator. In this mode, no travel-dependent switch off occurs in the end position.

⚠ CAUTION: CHECK MAXIMUM PARAMETERIZED TORQUE

Please note that, during motor operation, only torque monitoring remains active, as travel adjustment will happen subsequently. Therefore, please check beforehand whether the maximum torque has been already parameterised.

Step 6 - Absolute and relative values on the display will change continuously along with position changes.

Figure 19 Position Change Selector Setting



Figure 20 Position Change Display

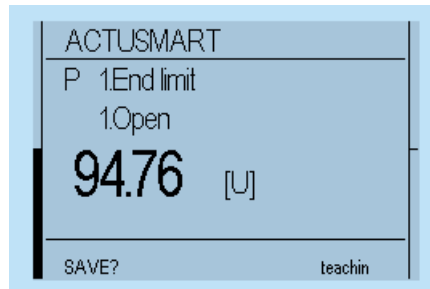

Step 7 - Manually move the actuator with the handwheel (see Section 2.1, or 2.6) or by motor via the control switch (black button) to the end position OPEN of the valve.

- Absolute value: Absolute value of the position feedback
- Relative value: the value to the other end position

Figure 21 Absolute Value

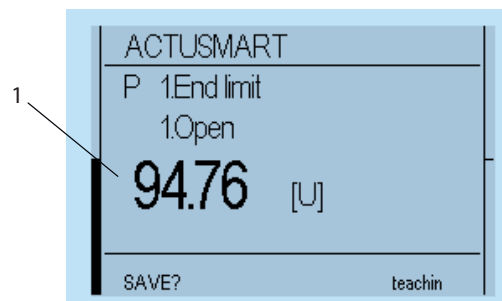

Display Overview:

1. Absolute value

Step 8 - When the desired end position OPEN of the valve is reached, move the selector switch back to the middle position. Thus, the line "TEACHIN" disappears.

Figure 22 Selector for End Position (Save)

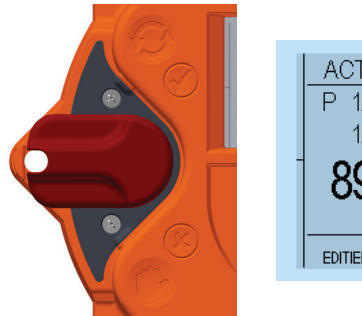
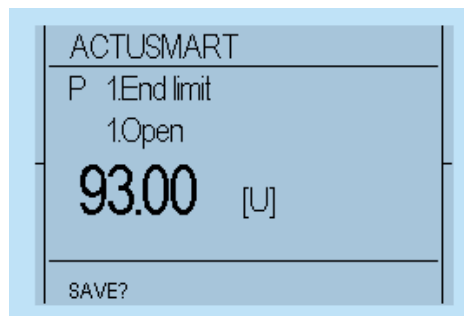

Figure 23 End Position Display



Step 9 - In order to confirm the end position (save), slightly flip up the selector switch towards ☺ and let it snap back to its neutral position.

Figure 24 Selector Setting Save (1)

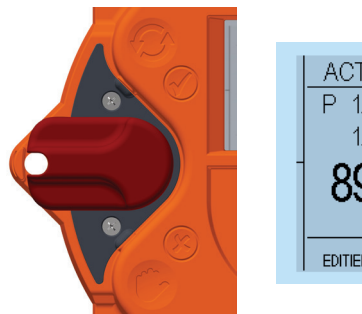

Figure 25 Selector Setting Save (2)

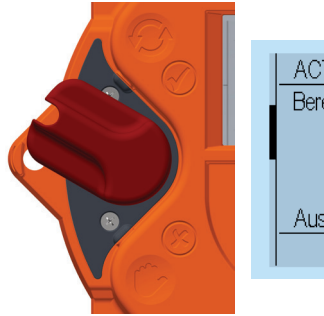
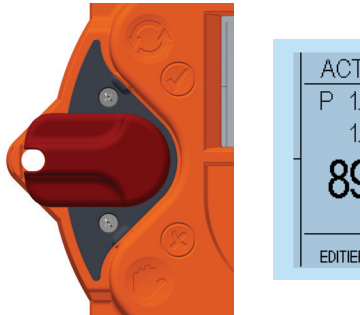

Figure 26 Selector Setting Save (3)



Step 10 - This changes the bottom line of the display for "SAVE?" to "EDIT?" and the end position is stored.

Figure 27 Selector Setting Display (1)

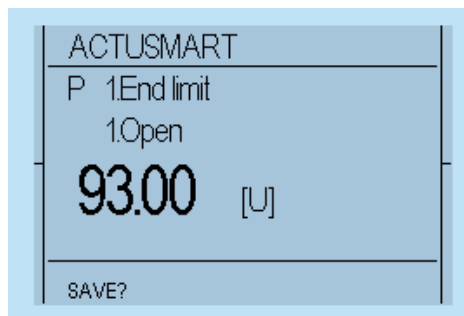
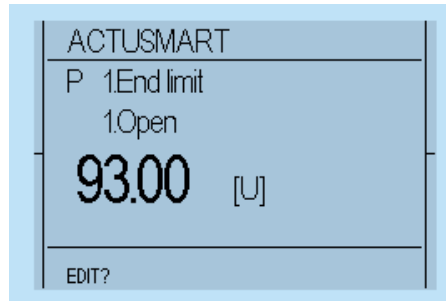

Figure 28 Selector Setting Display (2)



5.4.2 End limit CLOSE

Repeat 5.4.1 but select "P 1.2 End limit - End limit CLOSE".

5.5 Final Step

Following commissioning, ensure covers are sealed and cable inlets are closed. Also, check the actuator for damaged paint (by transportation or installation) and take necessary steps to repair if needed.

Section 6: Control Unit

The controller is intended to monitor and control the actuator and provides the interface between the operator, the control system and the actuator.

6.1 Operating Unit

Operation relies on two switches: the control switch and a padlock-protected selector switch. Information visualization is provided by 4 integrated indicator lights, as well as the graphic display. For better visibility, switch symbols (☑, ✘, ⊕, ⊖) are on the cover.

Figure 29 Operating Unit Controls

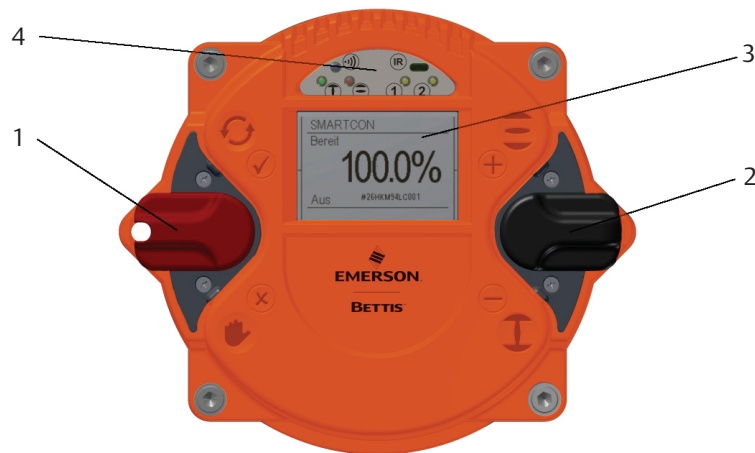

Display Overview:

1. Selector Switch
2. Control Switch
3. Graphic Display
4. LED Display

The control switch has dual function.

The controller cover may be wiped clean with a damp cloth.

The mounting position of the control unit can be turned in 90° steps (see Section 4.2).

6.2 Display Elements

6.2.1 Graphic Display

The graphic display used in the controller allows text display in different languages.

Figure 30 Display (1)

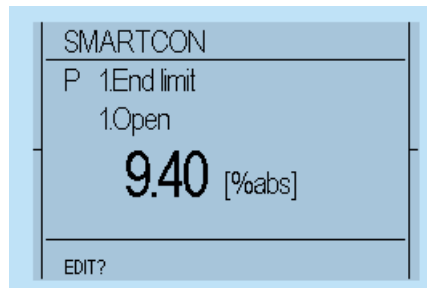

During operation, the displays shows the position of the actuator as a percentage, operation mode and status. When using the option "identification", a customer-specific label is shown at the bottom of the display (e.g., PPS Number).

Figure 31 Display (2)

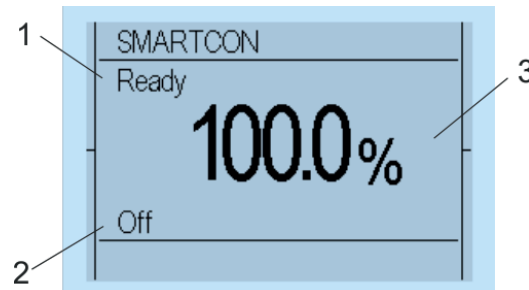

Display Overview:

1. Status
2. Operation Mode
3. Position

6.2.2 LED Display

To provide users with better status information, basic status data is displayed using 4 color LEDs. As the device powers up, it undertakes a self-test whereby all 4 LEDs briefly lit up simultaneously.

Figure 32 LED Display

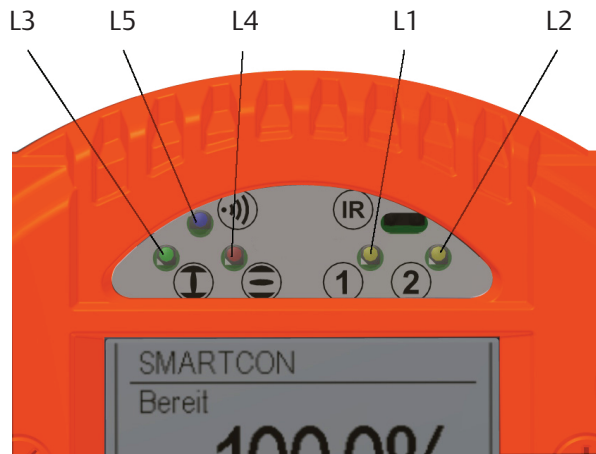

Table 2. LED Colour Legend

Description	Colour	Lits up	Flashes quickly	Flashes slowly	Does not light up
L1	Yellow	No torque error	Torque fault	—	—
L2	Yellow	Ready (operational readiness)	Path error (no operational readiness!)	—	Error (no operational readiness) motor temperature, supply voltage absent, internal error
L3 ⁽¹⁾	Red	OPEN	Moving to OPEN position	Applies upon torque-dependent opening: Occurs when the end position OPEN is reached but the cut-out torque has not yet been reached	Actuator is not in the open position.
L4 ⁽¹⁾	Green	Closed	Moving to CLOSED position	Applies upon torque-dependent closing: Occurs when the end position CLOSED is reached but the cut-out torque has not yet been reached	Actuator is not in the closed position.
L5	Blue	Bluetooth enabled	Bluetooth data transmission	Bluetooth ON, no data transmission	Bluetooth/Infrared OFF
	Red	Infrared ON	Infrared data transmission	Infrared ON	

6.3 Operation

The actuator is operated via the switches located on the controller (selection and control switch). All actuator settings can be entered with these switches. Furthermore, configuration is also possible via the IR interface or the Bluetooth Interface (see Section 10). Flip the switch up or down to regulate the parameter menu scrolling speed.

Figure 33 Neutral Position

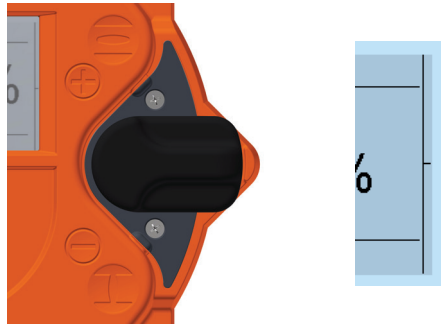

Figure 34 Slight Switch Flip (It Will Move to the Next Parameter)

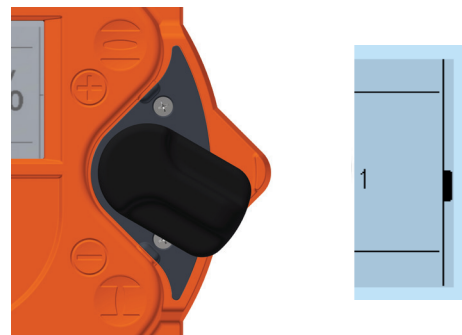

Figure 35 Halfway Switch Flip (Jump to the Next Parameter Category)

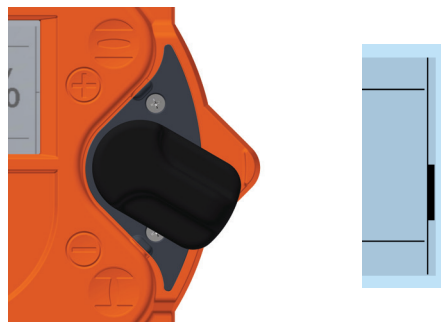
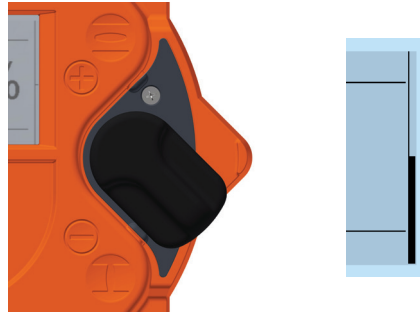



Figure 36 Full Switch Flip (Jump to the End of the Menu)**6.3.1 Operation Mode**

Use the selector switch (red) to determine the various operating states of the actuator. In each of these positions, it is possible to block the switch by means of a padlock and thus protect the actuator against unauthorized access.

The selector switch has the following positions:

Table 3. Selector Positions

Position	Function
OFF	The actuator can be neither operated via the remote control nor via the control switches of the controller.
Local 	It is possible to operate the actuator by motor via the control switch. Control via the remote inputs may be possible with appropriate configuration (superimposed control commands, emergency commands)
Remote 	The actuator is ready to process control commands via input signals. The control switch for the motor operation of the actuator is disabled.

Besides defining the operational status, the selector switch is used in configuration mode to confirm or cancel parameter inputs.

Depending on the selector switch position, the control switch performs different functions:

Table 4. Control Switch Positions

Position	Function
Selector switch in the OFF position:	The control switch is used to scroll up or down through the menu according to internal symbolism. From the neutral position towards ⊕ you reach the status and history data areas. Towards the ⊖ symbols you reach the parameter menu. Here, the selection switch either confirms ✓ or rejects ✗ the current input according to associated symbolism.
Selector switch in the REMOTE position ⊕:	The control switch gives you access to status, history data and parameter area.
Selector switch in the LOCAL position ⊖:	With the control switch, the actuator can be operated by motor. You may also operate the actuator in inching and self-hold mode. Switches are spring-loaded to snap back automatically into their neutral position. (To confirm a control command, the control switch must be pushed all the way into its mechanical locking position.)

6.3.2 Configuration

In principle, all parameters are shown as numbers in the corresponding parameter point. From the actuator menu, use the control switch to access different menu points. The lower left corner of the display shows the "EDIT" option.

Figure 37 Configuration Display (1)

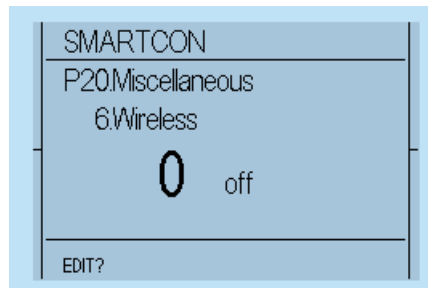

Confirm the selector switch (with a slight flip upwards, towards ☑, (see Figure 24, to Figure 28,) to change the selected parameter. To confirm this input readiness, the display changes from "EDIT" to "SAVE".

Figure 38 Configuration Display (2)

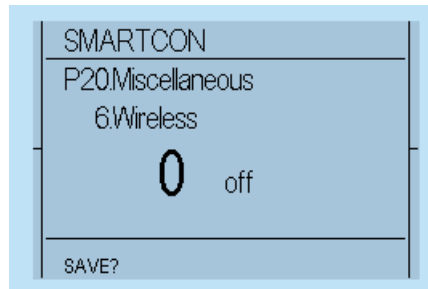

Move the control switch towards to the characters to change the parameter. ⊕ or ⊖ (see Figure 33 to Figure 38). After reaching the desired parameter value, confirm the value with the selector switch (again, flip it slightly towards ☑, (see Figure 24 to Figure 28).

6.3.3 Configuration Example

As an example, we will change parameter P20.6 (wireless) from 0 (wireless off) to 2 (Bluetooth communication on). Thus, the Bluetooth connection is activated for a short time and then deactivated again automatically:

Step 1 - The operating and control switch must be in the neutral position.

Figure 39 Selector Switch (1, Red) Control Switch (2, Black)

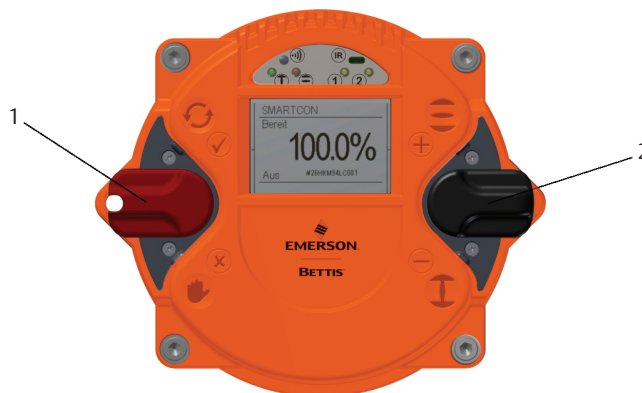

Step 2 - Now, move the control switch down (towards) until the menu item "P 20.6 Miscellaneous - Wireless" is displayed.

Figure 40 Control Switch Flipped Down

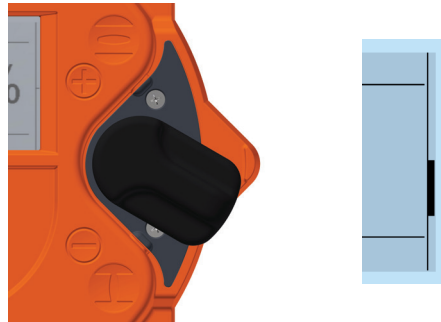
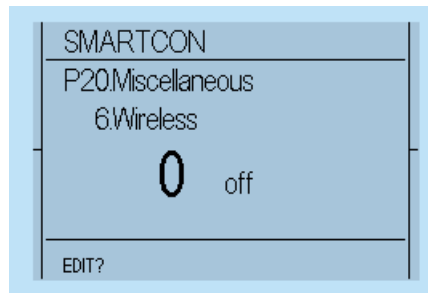

Figure 41 Display (1)



Step 3 - Afterwards, flip up slightly the selector switch (towards) and let it snap back to its neutral position.

Figure 42 Selector Switch in Neutral Position

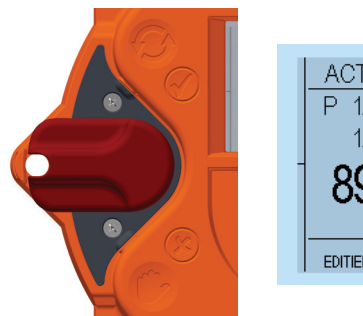

Figure 43 Selector Switch Flipped Up

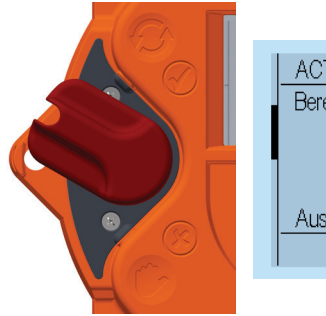
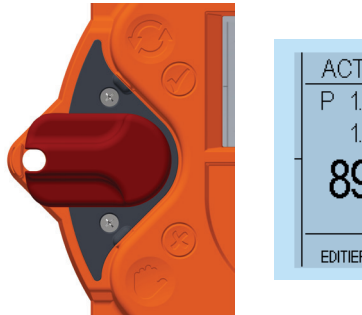

Figure 44 Selector Switch in Neutral Position



Step 4 - This changes the bottom line of the display from "EDIT?" to "SAVE?".

Figure 45 Display (2)

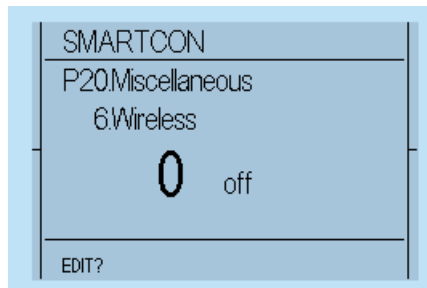
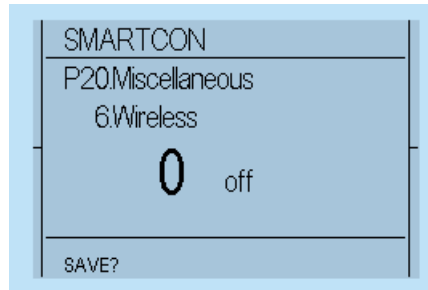

Figure 46 Display (3)



Step 5 - Flip up the control switch (toward) to change the value from 0 (off) to 2 (Bluetooth).

Figure 47 Control Switch Flipped Up

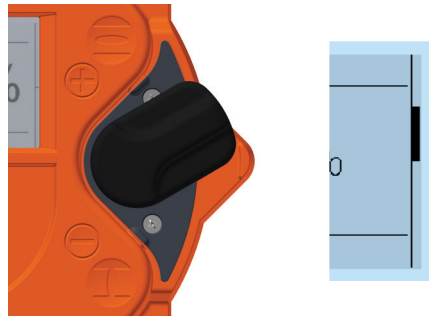
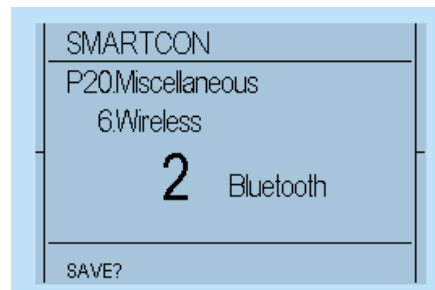

Figure 48 Switch to One



Step 6 - If the value changes to 1, confirm the selection by flipping the selector switch halfway up (towards) and letting it snap back to its neutral position (see Figure 42 til Figure 46).

Figure 49 Selector Switch Flipped Halfway Up

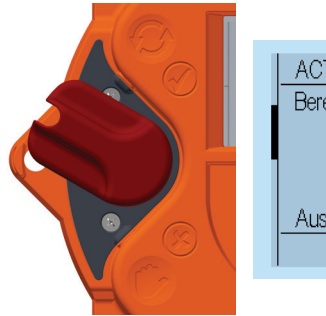
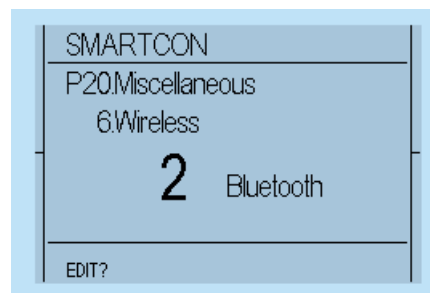

Figure 50 Display After Confirming Selection



Step 7 - This changes the bottom line of the display from "SAVE?" to "EDIT?" and the parameter is stored.

6.3.4 "TEACHIN"

Furthermore, certain parameters (end positions, intermediate positions), can be set using "TEACHIN". Thus, their configuration is greatly simplified.

After selecting the appropriate menu item (for example: End position) and changing the input type from "EDIT?" to "SAVE?", move the selector switch (red) to "manual mode" and lock it into place. As you do so, the display will show the message "TEACHIN" and the current position value will be applied continuously to the parameter value. In this mode, further to manual operation by hand wheel, the actuator can be motor-driven with the control switch to the desired position. (see Section 5.4.1)

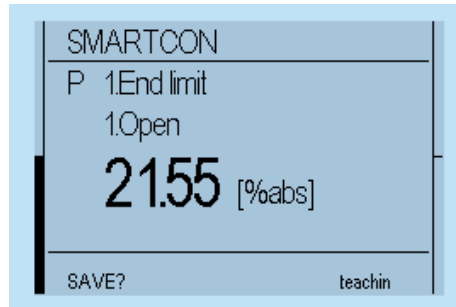
Figure 51 'Teachin' on Display**⚠ CAUTION: MAXIMUM TORQUE MUST BE ALREADY SET**

Please note that, during motor operation, only torque monitoring remains active, as travel adjustment will happen subsequently. Therefore, please check beforehand whether the maximum torque has been already set.

After reaching the desired, position, move the selector switch back to the neutral position. Finally, the parameter value must still be saved by flipping the selector switch halfway up and letting it snap back to the neutral position (see Figure 42 to Figure 46).

Section 7: Parameter Menu

For each parameter group, you can find a description tabular overview of the menu items and possible configurations. The parameter list below also includes all possible options per menu item. Please note that some of the menu items listed and described may not be available with your configuration.

7.1 Parameter Group: End Limit

These parameters are used to configure the end position and switch off behavior of the actuator. It is important to ensure that the basic mechanical configuration described in Section 5.4 has already been made.

⚠ CAUTION: SET CORRECT PARAMETERS

Ensure that these parameters are set during commissioning before operating the actuator. In addition, the settings in the "Torque" menu (see Section 7.2) must be compared with the permissible values of the valve and corrected as appropriate)

⚠ CAUTION: NOTE OPEN/CLOSE VALUES

Generally, 100% stands for fully open and 0% for fully closed. Please note that these values cannot be changed.

Table 5. End Limit Parameter Group

	Menu Item	Sub Menu Item	Poss. Setting	Notes / Comments
P1.1	End limit	Open	TEACHIN; 0 - 100U ¹⁾	The parameter value can be set using TEACHIN. With a known travel, the second end position can be entered after setting the first end position
P1.2	End limit	Close	TEACHIN; 0 - 100U ¹⁾	The parameter value can be set using TEACHIN. With a known travel, the second end position can be entered after setting the first end position
P1.3	End limit	Switch off Open	by travel (0)	The actuator uses end-position signals to switch off and report the end position
			by torque (1)	The actuator signals the end position or stops the motor only after reaching the specified torque with the proviso that it has reached the end position. If the end position signal is not reached, the actuator reports an error
			by torque1 (2)	Like torque, but in the end position range, this is also extended when the positioning command is released, until the torque is reached
			by torque2 (3)	Like torque1, however, an actuating command is automatically generated additionally in the end position range so that the end position in the end position range is approached even without a positioning command
			by travel1 (4)	Like travel, however, the actuator still continues to drive the set Overrun time after reaching the end position, even when the positioning command is released. Only relevant if Overrun time (P1.10, P1.11) is greater than 0
P1.4	End limit	Switch off Close	by travel (0)	The actuator uses end-position signals to switch off and report the end position
			by torque (1)	The actuator signals the end position or stops the motor only after reaching the specified torque with the proviso that it has reached the end position. If the end position signal is not reached, the actuator reports an error
			by torque1 (2)	see P1.3
			by torque2 (3)	see P1.3
			by travel1 (4)	see P1.3
P1.5	End limit	Closing direction	right (0)	Actuator is designed for clockwise = closing
			left (1)	Reverse direction of rotation. Counterclockwise = closing. The crossing of all signals and commands is performed by the controller
P1.6	End limit	Rot. sense pos.	0	Rotation sense of the Potentiometer.
			1	No function in Bettis RTS CM series
P1.7	End limit	LED function	Close=green (0)	Definition of the LED color of the CLOSED or OPEN end position indication
			Close=red (1)	
P1.8	End limit	End limit hyst	0, 1 - 10,0%	Hysteresis range for end position signals: Example: End position hysteresis 1% means that the End position OFF is reached when closing 0%, and will be left when opening only at 1%, i.e., a re-closing can only take place after leaving this hysteresis
P1.9	End limit	Ramp	0.1 - 100%	When approaching the end position, the speed is reduced
P1.10	End limit	Range	0 - 100%	End position range for torque (P1.3, P1.4). Permissible range in which the torque is to be achieved. If the actuator comes to the end of the end position range, the motor shuts off even if the torque has not been reached
P1.11	End limit	Overrun Open	0 - 60s	Switch-off delay after reaching the end position see travel1 (P1.3, P1.4)
P1.12	End limit	Overrun Open	0 - 60s	Switch-off delay after reaching the end position travel1 (P1.3, P1.4)

¹⁾ representative for CM03

⚠ CAUTION: NOTE TRAVEL LIMITS

When installing the actuator on a gear or a thrust unit, please take into account the limits and ratio of the gear / thrust unit at parametrization.

⚠ CAUTION: SET LIMITS CORRECTLY

When using end limit switch off by torque, the end position limit must be set before reaching the torque limit. Accordingly, the actuator will only signal the final end position if the configured torque and the associated end position are reached. If the end position is not reached, a torque error is reported (see Section 6.2.2)

7.2 Parameter Group: Torque

If no torque was specified with the order, the actuator is supplied from the factory with the maximum configurable torque.

Table 6. Torque Parameter Group

	Menu Item	Sub Menu Item	Poss. Setting	Notes / Comments
P2.1	Torque	Open	8 - 32Nm ²⁾	Switch off torque in OPEN direction CAUTION: The range can be restricted via the menu item P2.3
P2.2	Torque	Close	8 - 32Nm ²⁾	As P2.1 but in CLOSED direction
P2.3	Torque	Torque limit	8 - 32Nm ²⁾	Torque to protect the valve, the gear box or the thrust unit This value limits the setting of the Parameters P2.1 and P2.2 and to prevent an erroneous increase above the allowed value of these two parameters
P2.4	Torque	Latching	Off (0)	Unassigned in RTS Compact Multi-Turn CM series

⚠ CAUTION: NOTE GEAR AND THRUST UNITS

When installing the actuator on an additional gear, please take into account the corresponding values of the gear / thrust unit as you enter the actuator parameters. To achieve an effective output torque (incl. gear) / output power (including thrust unit) ratio, the ratio of gear/thrust unit must be considered.

7.3 Parameter Group: Speed

Table 7. Speed Parameter Group

	Menu Item	Sub Menu Item	Poss. Setting ²⁾	Notes / Comments
P4.1	Speed	Local Open	2,5 - 72,2min ⁻¹	Output speed for local operation in direction OPEN
P4.2	Speed	Local Close	2,5 - 72,2min ⁻¹	As P4.1 but in direction CLOSE
P4.3	Speed	Remote Open	2,5 - 72,2min ⁻¹	Output speed for remote operation in direction OPEN
P4.4	Speed	Remote Close	2,5 - 72,2min ⁻¹	As P4.3 but in direction CLOSE
P4.5	Speed	Emergency Open	2,5 - 72,2min ⁻¹	Output speed for emergency operation in direction OPEN
P4.6	Speed	Emergency Close	2,5 - 72,2min ⁻¹	As P4.5 but in direction CLOSE
P4.7	Speed	Torque-dependent.	2,5 - 72,2min ⁻¹	seal-tight speed. Speed at which the actuator runs near the end position at torque-dependent switch off (see P1.3 u. P1.4)
P4.8	Speed	Minimum	2,5 - 72,2min ⁻¹	Minimum speed

CAUTION: NOTE MAXIMUM SPEED LIMITS

The max. speed for the 24VDC actuator version is reduced to 20 rpm.

7.4 Parameter Group: Ramp (optional)

The start ramp can be set separately for each operation mode. Thus, a 100% start ramp means that the motor attains its maximum speed in about a second. Higher speeds (see Section 7.3) lead to shorter runtimes. If the ramp is set below 100%, the starting time increases in an inversely proportional fashion.

Table 8. Ramp Parameter Group

	Menu Item	Sub Menu Item	Poss. Setting	Notes / Comments
P5.1	Ramp	Local	5 - 100%	Start ramp for local operation
P5.2	Ramp	Remote	5 - 100%	Start ramp for remote operation
P5.3	Ramp	Emergency	5 - 100%	Start ramp for emergency operation

7.5 Parameter Group: Control

Table 9. Control Parameter Group

	Menu Item	Sub Menu Item	Poss. Setting	Notes / Comments
P6.2	Control	Ready delay	0 - 10 sec.	Drop-out delay for the ready signal (Binary outputs)
P6.5 ³⁾	Control	24V output	0	24V auxiliary output is deactivated (Section 16.5). The function of the auxiliary input is still activated.
			{1}	24V auxiliary output is activated (Section 16.5).
P6.6	Control	Min. impuls	0.1 - 2.0 sec	Minimum switch-on time of the motor.

³⁾ since firmware 1.303

7.6 Parameter Group: Password

The actuator control can be password-protected to prevent access at different levels. It is possible to prevent entry by unauthorized personnel or to entirely lock motor operation.

Default password is set to "000" and thus deactivated.

You can use both numbers and capital letters in your password. After entering a password, password protection is activated. To remove password protection, enter an empty password (000).

When accessing a password-protected parameter, the user is automatically prompted for the password. Only after correctly entering the password, is it possible to change the corresponding parameters.

Table 10. Password Parameter Group

	Menu Item	Sub Menu Item	Poss. Setting	Notes / Comments
P7.1	Password	Reading PWD	3-digit	Status display and history data are still viewable; access to the parameter menu is locked until this password is introduced. Parameter menu scrolling is only enabled after entering the password. Electric motor operation is unlocked
P7.2	Password	Writing PWD	3-digit	Status display, history data and parameter menu can be viewed. However, parameters become read-only
P7.3	Password	Bluetooth PWD	15-digit	Password for the Bluetooth connection, empty password deactivates the password request

7.7 Parameter Group: Position

In addition to OPEN and CLOSED end positions, you may define intermediate positions. These can be used as feedback signals for the binary outputs or as target value for fix position approach.

⚠ CAUTION: CHANGING END POSITIONS

If you change the end positions (see Section 7.1 intermediate positions are retained percentage-wise, i.e., the absolute positions of the intermediate positions change.

Table 11. Position Parameter Group

	Menu Item	Sub Menu Item	Poss. Setting	Notes / Comments
P8.1	Position	Intermed. pos.1	TEACHIN 0 - 100%	Position value of intermediate position 1
P8.2	Position	Intermed. pos.2	TEACHIN 0 - 100%	see above
P8.3	Position	Intermed. pos.3	TEACHIN 0 - 100%	see above
P8.4	Position	Intermed. pos.4	TEACHIN 0 - 100%	see above
P8.5	Position	Emerg. position	TEACHIN 0 - 100%	Position value of the emergency position
P8.6	Position	Hysteresis	0,1 - 10,0%	Hysteresis range of intermediate positions. Within this hysteresis, no repositioning occurs upon reaching the intermediate positions (option: fix position approach). Furthermore, the output functions for position = intermediate position are active within this range (see P10.1)

7.8 Parameter Group: Binary Inputs

The controller is equipped with 5 freely configurable binary inputs. Please find further information on technical data of the binary inputs in Section 16.2. Binary inputs are also effective during actuator control via Profibus (option).

Default binary inputs are as follows:

- Input 1: OPEN
- Input 2: CLOSED
- Input 3: STOP
- Input 4: EMERGENCY OPEN
- Input 5: EMERGENCY CLOSED

Table 12. Binary Inputs Parameter Group (1)

	Menu Item	Sub Menu Item	Poss. Setting	Notes / Comments
P9.1	Binary Input	Input 1	0: no function	This input has no function
			1: Open	OPEN command in REMOTE mode (selector switch in position REMOTE).
			2: Closed	CLOSED command in REMOTE mode (selector switch in position REMOTE).
			3: Stop	STOP command in REMOTE mode (selector switch in position REMOTE).
			4: Open Self-hold	Self-hold for OPEN, i.e., a short pulse is sufficient and the actuator moves then into the end position. Use the STOP command to stop the actuator.
			5: Closed Self hold	Self-hold for CLOSED, see OPEN SELF-HOLD
			6: Emergency Open	Superimposed run command; run the actuator in direction OPEN regardless of whether the selection switch is set to REMOTE or LOCAL operation
			7: Emergency Closed	Superimposed run command; run the actuator in direction CLOSED regardless of whether the selection switch is set to REMOTE or LOCAL
			8: Release	The actuator may be operated only with a switched signal. Both in local and remote operation
			9: Open/Closed	The actuator moves towards OPEN if input is active and towards CLOSED otherwise
			10: Close/Open	The actuator moves towards CLOSED if input is active and towards OPEN otherwise
			11: Positioner	Release of the positioner
			12: Open inv.	As open but active low
			13: Close inv.	As CLOSED but active low
			14: Stop inv.	As STOP but active low
			15: Open Self-Hold inv.	As Open Self-Hold but active low
			16: Closed Self-Hold inv.	As Closed Self-Hold. but active low
			17: Emergency-Open inv.	As Emergency-Open but active low
			18: Emergency-Closed inv.	As Emergency-Closed but active low
			19: Block	With activated (switched) signal, the actuator is locked for operation also in local mode
			20: Contoller lock	Positioner lock
			21: Release Local	The actuator may be operated only with a switched signal.
			22: Block Local	As Release Local but active low
23: Lock Open	Trigger lock OPEN (in LOCAL and REMOTE mode). Actuator moves with the highest priority to OPEN; command continues internally active after reaching the end position OPEN. Dropping only with LOCK OFF, Supply OFF or operating mode OFF.			

Table 13. Binary Inputs Parameter Group (2)

	Menu Item	Sub Menu Item	Poss. Setting	Notes / Comments
P9.1	Binary Input	Input 1	24: Lock Closed	Trigger lock CLOSED (in LOCAL and REMOTE mode). Actuator moves with the highest priority to CLOSED; command continues internally active after reaching the end position CLOSED. Dropping only with LOCK OFF, Supply OFF or operating mode OFF.
			25: Lock Off	Drop the lock
			26: Failsafe	Trigger the failsafe function in all operating modes (only functional in failsafe actuators)
			27: Failsafe inv.	As Failsafe but active low
			28: Lock Open inv.	As Lock Open but active low
			29: Lock Closed inv.	As Lock Closed but active low
			30: Lock Off inv.	As Lock Off but active low
			31: Intermediate position1	Approach intermediate position 1 (P8.1) in REMOTE mode (fix position approach). There is no repositioning upon reaching the intermediate position within the hysteresis (see P8.6) Higher priority than intermediate position 2, 3 and 4
			32: Intermediate position2	As intermediate position 1, but with higher priority than intermediate positions 3 and 4
			33: Intermediate position3	As intermediate position 1 but with higher priority than intermediate position 4
			34: Intermediate position4	As intermediate position 1, but with lowest priority
			35: Emergency position	Approach emergency position (P8.5). As intermediate position 1 but with higher priority than intermediate positions 1, 2
			36: Intermediate position1 inv.	As Intermediate position 1 but active low
			37: Intermediate position2 inv.	As Intermediate position 2 but active low
			38: Intermediate position3 inv.	As Intermediate position 3 but active low
			39: Intermediate position4 inv.	As Intermediate position 4 but active low
			40: Emergency position inv.	As Emergencyposition but active low
			41: Travel Open	Reserved for future use
			42: Travel Close	Reserved for future use
			43: Travel Open inv.	Reserved for future use
44: Travel Close inv.	Reserved for future use			
45: Failsafe lock	Reserved for future use (only for Failsafe actuators)			
46: Failsafe lock inv.	Reserved for future use (only for Failsafe actuators)			
P9.2	Binary Input	Input 2	see Input 1	---
P9.3	Binary Input	Input 3	see Input 1	---
P9.4	Binary Input	Input 4	see Input 1	---
P9.5	Binary Input	Input 5	see Input 1	---

7.9 Parameter Group: Binary Outputs

The controller is equipped with 8 freely configurable binary outputs. Please find further information on technical data of the binary outputs in Section 16.1. Provided with external supply, binary outputs are optically isolated from the rest of the controller.

Default binary outputs are as follows:

- Output 1: Ready
- Output 2: End position OPEN
- Output 3: End position CLOSED
- Output 4: Run OPEN
- Output 5: Run CLOSED
- Output 6: Torque
- Output 7: LOCAL
- Output 8: REMOTE

Table 14. Binary Outputs Parameter Group (1)

	Menu Item	Sub Menu Item	Poss. Setting	Notes / Comments
P10.1	Binary Output	Output 1	0: User defined	Optional
			1: Ready	Actuator is ready
			2: Fault	General fault; actuator is not ready
			3: Open	Actuator is in open position
			4: Closed	Actuator is in closed position
			5: Running Open	Actuators runs in direction Open
			6: Running Closed	Actuators runs in direction Closed
			7: Runing	Actuator is running in either Open or Closed
			8: Torque Open	Switch off torque was reached in Open direction-actuator has been switched off
			9: Torque Closed	Switch off torque was reached in Closed direction-actuator has been switched off
			10: Torque	Switch off torque was reached in either Closed or Open direction
			11: Travel Open	The Open end position has been reached
			12: Travel Closed	The Closed end position has been reached
			13: Pos. > Int.1	Position > Intermediate position 1
			14: Pos. < Int.1	Position < Intermediate position 1
			15: Pos. > Int.2	Position > Intermediate position 2
			16: Pos. < Int.2	Position < Intermediate position 2
			17: Pos. > Int.3	Position > Intermediate position 3
			18: Pos. < Int.3	Position < Intermediate position 3
			19: Pos. > Int.4	Position > Intermediate position 4
			20: Pos. < Int.4	Position < Intermediate position 4
21: Local	Local operating mode (selector switch in position)			

Table 15. Binary Outputs Parameter Group (2)

	Menu Item	Sub Menu Item	Poss. Setting	Notes / Comments
P10.1	Binary Output	Output 1	22: Remote	Remote operating mode (selector switch in position Remote)
			23: Off	Off operating mode (selector switch in the Off position)
			24: No function	No function
			25: Motor error	The motor temperature sensor has reported an error
			26: Always	Signal is always on
			27: Never	Signal is always off
			28: Binary Input 1	Forwarding of binary input to output
			29: Binary Input 2	Forwarding of binary input to output
			30: Binary Input 3	Forwarding of binary input to output
			31: Binary Input 4	Forwarding of binary input to output
			32: Binary Input 5	Forwarding of binary input to output
			33: Torque Open ma.	As Torque OPEN although it will suppress (mask) this signal in the end position upon torque-dependent switch off.
			34: Torque Closed ma.	As Torque CLOSED although it will suppress (mask) this signal in the end position upon torque-dependent switch off.
			35: Ready Remote	Ready and Remote operating mode
			36: Ready Local	Ready and Local operating mode
			37: Ready Local/remote	Ready and Local or Remote mode
			38: Lock Open	Lock OPEN is enabled. OPEN command is internally queued with the highest priority and will not be dropped even in the end position
			39: Lock Closed	Lock CLOSED is enabled. CLOSED command is internally queued with the highest priority and will not be dropped even in the end position
			40: Failsafe OK1	Failsafe OK (only for failsafe actuators)
			41: Failsafe OK2	Failsafe OK and Ready (only for failsafe actuators)
42: Failsafe OK3	Failsafe OK, Ready and Remote (only for failsafe actuators)			
43: Lock	Lock Open or Lock Closed is enabled.			
44: Ready/TorqueOK	Actuator is ready and no torque switch off			
45: Ready/Remote/TorqueOK	Actuator is ready for operation in REMOTE mode and no torque switch off			
46: Pos.=Int1	Position = Intermediate position 1. The width of the interval is set with the parameter P8.6.			

Table 16. Binary Outputs Parameter Group (3)

	Menu Item	Sub Menu Item	Poss. Setting	Notes / Comments
P10.1	Binary Output	Output 1	47: Pos.=Int2	Position = Intermediate position 2. The width of the interval is set with the parameter P8.6.
			48: Pos.=Int3	Position = Intermediate position 3. The width of the interval is set with the parameter P8.6.
			49: Pos.=Int4	Position = Intermediate position 4. The width of the interval is set with the parameter P8.6.
			50: Pos.=EmergPos	Position = emergency position. The width of the interval is set with the parameter P8.6.
			51: Bus Bit 1	In existing bus interface (hardware option) the output is set according to the selected bit bus. ⁴⁾
			52: Bus Bit 2	
			53: Bus Bit 3	
			54: Bus Bit 4	
			55: Bus Bit 5	
			56: Bus Bit 6	
			57: Bus Bit 7	Configurable output function
			58: Bus Bit 8	
			59: Virtual 1	
			60: Virtual 2	
			61: Virtual 3	Configurable output function
			62: Virtual 4	
			63: Line voltage OK	Supply voltage for the motor is OK
64: Control voltage OK	The auxiliary voltage for the SMARTCON control is OK. This function is only available if the auxiliary voltage output is not switched on (P6.5 to 0)			
65: Oil pressure OK	The oil pressure is higher than the minimum pressure (P6.10)			
66: Oil level OK	The oil level is OK			
67: Pump OK	The temperature sensor in the pump motor and the external motor protection have not tripped			
4-5 P10.2	Binary Output	Output conf. 1	0: normal	Output 1 is set to normal, i.e. if the condition in point P10.1 is met, Output 1 is set to HIGH (active HIGH)
			1: inverted	If the condition in point P10.1 is met, Output 1 is set to LOW (active LOW)
			2: norm. flashing	If the condition in point P10.1 is met, Output 1 starts blinking (active HIGH)
			3: inv. flashing	If the condition in point P10.1 is not met, Output 1 starts blinking (otherwise it is set to HIGH)
P10.3	Binary Output	Output 2	see Output 1	---
P10.4	Binary Output	Output 2 Konf.	see Output 1 conf.	---
P10.5	Binary Output	Output 3	see Output 1	---
P10.6	Binary Output	Output 3 Konf.	see Output 1 conf.	---
P10.7	Binary Output	Output 4	see Output 1	---
P10.8	Binary Output	Output 4 Konf.	see Output 1 conf.	---
P10.9	Binary Output	Output 5	see Output 1	---

P10.10	Binary Output	Output 5 Konf.	see Output 1 conf.	---
P10.11	Binary Output	Output 6	see Output 1	---
P10.12	Binary Output	Output 6 Konf.	see Output 1 conf.	---
P10.13	Binary Output	Output 7	see Output 1	---
P10.14	Binary Output	Output 7 Konf.	see Output 1 conf.	---
P10.15	Binary Output	Output 8	see Output 1	---
P10.16	Binary Output	Output 8 Konf.	see Output 1 conf.	---

⁴⁾ from Firmware 1.323

⚠ CAUTION: NOTE SET TORQUE AND POSITION

When using the point torque-dependent OPEN or torque-dependent CLOSED (see Section 7.1, Menu P1.3 u. P1.4) the actuator will only be open or closed when the set torque and the associated end position is reached. If the end position is not reached, a torque error is reported (see Section 6.2.2)

7.10 Parameter Group: Position Output (optional)

Position output is used to indicate the current position of the actuator using 0/4-20 mA; it can retrofitted using software code.

If this option is not enabled, the menu point shows the message "inactive".

No adjustment to the end positions or the travel is required. Adjustment is automatically performed during the configuration of travel limit positions (see Section 7.1)

No further settings are necessary for torque-dependent switch off, because the controller exclusively uses travel limit positions for the calculation. Regardless of whether this is defined by the torque or the travel limit positions.

The factory default setting is:

4mA at 0% position 20mA at 100% position

Table 17. Position Output Parameter Group

	Menu item	Sub Menu Item	Poss. Setting	Notes / Comments
P11.1	Position Output	Function 1	0: Off	mA output disabled
			1: Position	mA output corresponds to the actual position value
			2: Pos. Valvechar.	mA output corresponds to the actual position value taking into account the valve characteristic
			3: Torque 1	mA output corresponds to the actual torque value
				torque = 100% Close: mA output = start
				torque = 0%: mA output = center
			4: Torque 2	torque = 100% Open: mA output = end
				mA output corresponds to the actual torque value
				torque = 100% Close: mA output = end
			5: Torque 3	torque = 0%: mA output = start
				mA output corresponds to the actual torque value
				torque = 150% Close: mA output = start
6: Torque 4	torque = 0%: mA output = center			
	mA output corresponds to the actual torque value			
	torque = 150% Open: mA output = end			
P11.2	Position Output	Start (at 0%)	0 - 20,5 mA [4mA]	mA value for the Closed (0%) position
P11.3	Position Output	End (at 100%)	0 - 20,5 mA [20mA]	mA-value for the On (100%) position
P11.4	Position Output	Calib. 20mA	-10% - +10%	Calibrating the output position during the setting of this parameter will output a 20mA (100%) signal. Use this parameter to calibrate accurately the 20mA output signal. (e.g., if you measure 19.8 mA at the output, just add 1% (0.2 mA - 1% of 20mA) to the displayed value)
P11.5	Analog Output	Function 2	see Function 1	
P11.6	Analog Output	Start (at 0%)	see Start	
P11.7	Analog Output	End (at 100%)	see End	
P11.8	Analog Output	Calib. 20mA 2	see Calib. 20mA 1	

7.11 Parameter Group: Step Mode

Step mode operation can be used to extend the operating time in certain ranges or for the whole travel; it is available in local, remote and emergency mode.

Step mode operation can be activated individually for the directions OPEN and CLOSED.

Cycle start, cycle end, cycle duration and interval time can be set separately for both directions. (see Figure 52)

Table 18. Step Mode Parameter Group

	Menu Item	Sub Menu Item	Poss. Setting	Notes / Comments
P12.1	Step mode function	Mode	disabled	Step mode operation is disabled
			enabled	Step mode operation is enabled in LOCAL, REMOTE and EMERGENCY operation
			Local only	Step mode mode is only enabled in LOCAL mode
			Remote only	Step mode mode is only enabled in REMOTE mode
			Local + Remote only	Step mode mode is enabled in REMOTE and LOCAL mode
P12.2	Step mode function	Start Open	0 - 100%	In OPEN direction, position in % from which the step mode operation should start
P12.3	Step mode function	End Open	0 - 100%	In OPEN direction, position in % of which the step mode operation should end
P12.4	Step mode function	Runtime Open	0,1 - 60	Runtime in OPEN direction
P12.5	Step mode function	Pause time Open	0,2 - 60	Pause time in OPEN direction
P12.6	Step mode function	Start Closed	0 - 100%	In CLOSED direction, position in % from which the step mode operation should start
P12.7	Step mode function	End Closed	0 - 100%	In CLOSED direction, position in % of which the step mode operation should end
P12.8	Step mode function	Run time Closed	0,1 - 60	Runtime in Closed direction
P12.9	Step mode function	Pause time	0,2 - 60	Pause time in Closed direction
P12.10	Step mode function	Timebase	{0: Seconds}	Time basis for run and pause times
			1: Minutes	
P12.11	Step mode function	Speed adaption	0:	Speed adaption not activated. Normal step mode function
			1:	Speed adaption is activated. The speed is reduced according to the runtime and pause time in the step mode range. (Example: Running time 1 sec and pause time 1 sec results in half the speed). If the minimum speed is undershot, the actuator clocks in the converted ratio with the minimum speed. The speed adjustment is only applicable to actuators of the type CM and AB CSC

Figure 52 Position Setting and Timing

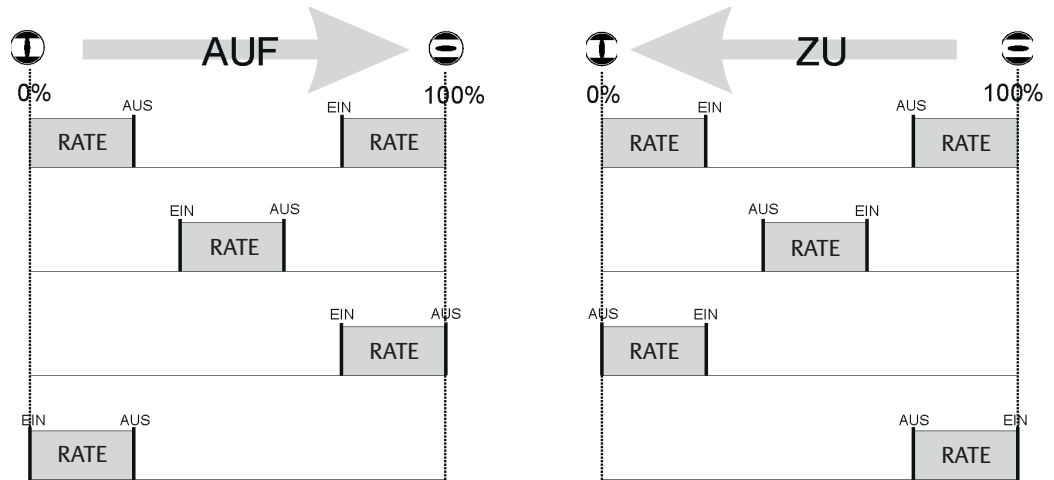

NOTE:

It is important to ensure that the mode of operation is not exceeded!
 The running info on the actuator (see 6.2.2) only flashes while the drive is running, ie during the break, no flash.

7.12 Parameter Group: Positioner (option)

The positioner SR option is used to control the electric actuator by means of a set point input 0/4-20 mA signal. The SR helps control the position of the actuator, i.e. the positioner ensures that the actual value and thus the position of the actuator matches the desired set point.

Table 19. Positioner Parameter Group (1)

	Menu Item	Sub Menu Item	Poss. Setting	Notes / Comments
P13.1	Positioner	Function	off	Positioner disabled
			1: Position	mA input for the position setpoint
			2: Pos. valvechar.	mA input for the position setpoint, taking into account the valve characteristic
P13.2	Positioner	Begin (at 0%)	0 – 20,5 mA [4,0 mA]	mA value of the setpoint for the CLOSED (0%) position
P13.3	Positioner	End (at 100%)	0 – 20,5 mA [20,0 mA]	mA value of the setpoint for the OPEN (100%) position
P13.4	Positioner	Dead band	0,1 – 10,0% [1,0%]	Tolerance range for the control deviation (set point position - actual position) where no adjustment occurs. The deadband should not be set too low to prevent actuator oscillation
P13.5	Positioner	Gain	1 – 100% [100%]	The gain (gradient) affects the positioning close to the target position. The smaller the gain selected (for example, 20%), the earlier the actuator starts reducing its speed in case of speed variable actuators on approaching the target position. In case of actuators with fixed speed (reversing starters) the speed reduction is done by pulsing (also see params P13.9 and P13.10). This provides a better positioning (smaller reachable deadband). A 100% setting disables this gradient
P13.6	Positioner	Live zero detect	Ignore	The setpoint monitoring (monitoring the setpoint to below approximately 2mA = loss of signal) is disabled
			Stop	Actuator stops on signal failure
			Open	Actuator moves to OPEN position
			Close	Actuator moves to CLOSED position on signal failure
			Emerg. pos.	On signal failure, the actuator moves to defined emergency position (see parameter P13.7)
Emerg. PID	Reserved for future use			
P13.7	Positioner	Emergency pos.	0 - 100% [50,0%]	Determination of the emergency position (Can also be set in the menu P8.5)
P13.8	Positioner	Calib. setpoint	-10% - +10%	Calibration value for the mA setpoint. Calibration process: By applying 20 mA on the setpoint input, this parameter is corrected until the readout matches 20 mA

Table 20. Positioner Parameter Group (2)

	Menu Item	Sub Menu Item	Poss. Setting	Notes / Comments
P13.9	Positioner	Min. impulse	{0,2 s}	Minimum activation time of the reversing contactors. For very small activation times (<0.3 - 0.5 s), the motor will be switched off during start-up process, which significantly increases mechanical wear on reversing contactors. With frequent periods of very small activation times (restless loop, small dead zone, clocking near to the target value), we therefore recommend electronic reversing contactors.
P13.10	Positioner	Period	{2.0 s}	This parameter is only relevant in Step mode when approaching the target position (parameter gain smaller than 100%) and determines the period of a run / pause cycle
P13.11	Positioner	Begin pos. (a0)	0.0 - 25.0% {2.0%}	Smallest controllable position other than the end position CLOSED. The range 0% - a0 will be just passed through. Use the parameter a0 to define the beginning of the allowable control range of the valve (e.g., blind spot for ball segment valves, etc.)
P13.12	Positioner	End pos. e0)	75.0 - 100.0% {98.0%}	Largest controllable position other than the end position OPEN. The area e0 . . . 100% is just passed through. Use the parameter e0 to define the end of the allowable control range of the valve
P13.13	Positioner	Begin setp. (a1)	0.0 - 25.0% {2.0%}	Below this value, the end position CLOSED is controlled. In the range 0% - a1 cannot be controlled (end position tolerance). The initial setpoint a1 is associated with a small hysteresis (1/4 of the deadband)
P13.14	Positioner	End setp. (e1)	75.0 - 100% {98.0%}	Above this value, the end position OPEN is controlled. The range e1 - 100% cannot be controlled (end position tolerance). The final setpoint e1 is associated with a small hysteresis (1/4 of the deadband)
P13.15	Positioner	Calib. setpoint offset	-10% - +10%	Calibration of zero for the input setpoint. 1% = 0.2mA

Figure 53 Assigning the position to the setpoint

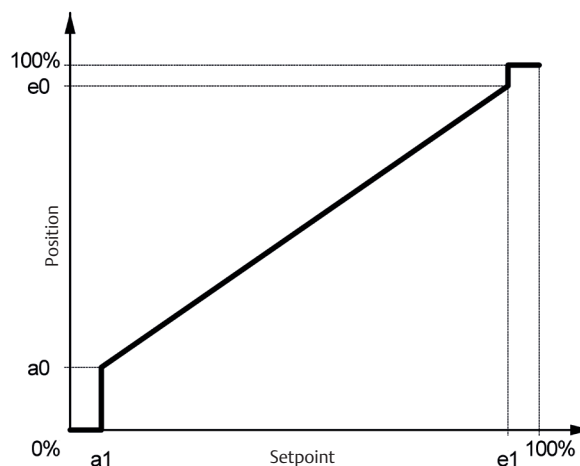

7.13 Parameter Group: PID Controller (optional)

The optional PID controller is used for controlling an external actual value (process variable) to a setpoint using 0/4-20 mA signal by readjusting the actuator.

Table 21. PID Controller Parameter Group (1)

	Menu Item	Sub Menu Item	Poss. Setting	Notes / Comments
P14.1	PID-controller	Function	0: disabled	PID controller disabled
			1: Position	The output of the PID controller corresponds to the position setpoint of the actuator. The positioning (tracking of the actual position to the setpoint) is done by the positioner (see 7.12).
			2: Speed	The output of the PID controller corresponds to the change of the position setpoint (speed) of the actuator. The positioning (tracking of the actual position to the setpoint) is done by the positioner (see 7.12). ⁵⁾
			3: Speed	The output of the PID controller corresponds to the change of the position setpoint (speed) of the actuator. The positioning (tracking of the actual position to the setpoint) is done by the positioner (see section 7.12). Hence a control mode similar to the Speed mode (see Setting 2, above) is possible also for actuators with constant speed. ⁶⁾
P14.2	PID-controller	External Setpoint	0: fixed	The PID controller uses an internal, fixed setpoint (see param P14.3).
			1: external	The PID controller uses the external setpoint. The adjustment of this setpoint is done with the params P13.2 and P13.3 (see section 7.12).
P14.3	PID-controller	Fixed setpoint	0 – 100%	Specification of the internal fixed setpoint
P14.4	PID-controller	Start (at 0%)	0 - 20,5 mA	mA value at 0% of the external actual value
P14.5	PID-controller	End (at 100%)	0 - 20,5 mA	mA value at 100% of the external actual value
P14.6	PID-controller	Gain (P)	+50,0 - 50,0	Gain (proportional value) of the PID-controller. A negative value reverses the effective direction of the PID-controller, e.g.: Positive gain: The actuator opens when the desired value is greater than the external actual value. Negative gain: The actuator closes when the desired value is greater than the external actual value.
P14.7	PID-controller	Reset time (I)	0 – 100,0 s	The shorter the reset time (integral time, integral value), the stronger is the effect of the integral component of the PID-controller. Values below 1,0 will disable the integral component.

Table 22. PID Controller Parameter Group (2)

	Menu Item	Sub Menu Item	Poss. Setting	Notes / Comments
P14.8	PID-controller	Lead time (D)	0 – 100,0 s	The larger the lead time (differential/derivative value), the stronger is the effect of the derivative component of the PID-controller. To reduce the influence of noise a first-order lag element with 1sec time constant is added (DT_1)
P14.9	PID-controller	Offset	-200 – 200%	The offset value will be added to the output value of the PID controller
P14.12	PID-controller	Live zero detect.	0: Ignore	The monitoring of the external actual value is disabled
			1: Stop	Actuator stops on signal failure of external actual value
			2: Open	On signal failure of external actual values, actuator moves to the OPEN position
			3: Closed	On signal failure of external actual values, actuator moves to the CLOSED position
			4: Emergency position	On signal failure of external actual values, actuator moves to the EMERGENCY position (see param P13.7)
			5: Emergency PID	Reserved for future use
P14.13	PID-controller	Calibration of ext. actual value	-10 - +10%	Calibration process: By applying 20mA to the external actual value input, this parameter is corrected until the readout matches 20 mA.
P14.14	PID-controller	Process begin	-32768 - +32767	Mantissa of the real process variable (beginning of external actual value)
P14.15	PID-controller	Process end	-32768 - +32767	Mantissa of the real process variable (end of external actual value)
P14.16	PID-controller	Process comma shift	-3 - +3	Position of the comma for process begin/end (P14.14, P14.15), e.g.: mantissa = 200, comma shift = -2/2, process value = 2.00/20000
P14.17	PID-controller	Process unit	--	Unit of the real process variable
P14.18	PID-controller	Dead band	0.1 - 10.0% [1.0%]	Tolerance range for the control deviation (set point – external actual value) where no adjustment occurs. ⁷⁾

⁵⁾ from firmware 1.338

⁶⁾ from firmware 1.340

⁷⁾ up to firmware 1.337

⁸⁾ up to firmware 1.337

7.14 Parameter Group: Profibus-DP (option)

PROFIBUS DP defines the technical and functional characteristics of a serial field bus system, which can be networked with distributed digital automation devices. PROFIBUS-DP is designed for the data exchange at the field level.

Central control devices such as PLC or PC communicate via a fast serial connection with distributed field devices such as input/output devices, valves and actuators.

Data exchange with these distributed devices is cyclical. The communication functions required are defined by the PROFIBUS-DP basic functions in accordance with EN 50 170.

NOTE:

The Profibus-DP option is a hardware option with which you should already be familiar upon ordering the actuator.

Subsequent installation of hardware components is possible but should only be performed by a professional Bettis installer or specially trained personnel.

The Profibus-DP interface is described in the separate manual "Profibus-DP for SMARTCON controllers".

7.15 Parameter Group: DeviceNet (option)

The DeviceNet field bus® is based on the CAN protocol and was originally developed by Rockwell Automation as an open field bus. Today, DeviceNet falls under the responsibility of ODVA (Open DeviceNet Vendors Association, Inc., <http://www.odva.org>) as an umbrella organization. DeviceNet is defined in EN 50325 2 and in IEC 62026 3. DeviceNet is a simple and powerful field bus system for the lowest field bus level to connect sensors and actuators (slaves) with the associated controllers in a network.

Subsequent installation of hardware components is possible but should only be performed by a professional

Bettis installer or specially trained personnel.

7.16 Parameter Group: Characteristic Curves (optional)

With this option, customers can enable travel-dependent torque characteristic curves.

With these characteristic curves, torque limits already set under menu item P2 (torque), can be further reduced depending on travel. Characteristics can be configured with the bluetooth application interface. (see Figure 54).

Figure 54 Characteristic Curves Display

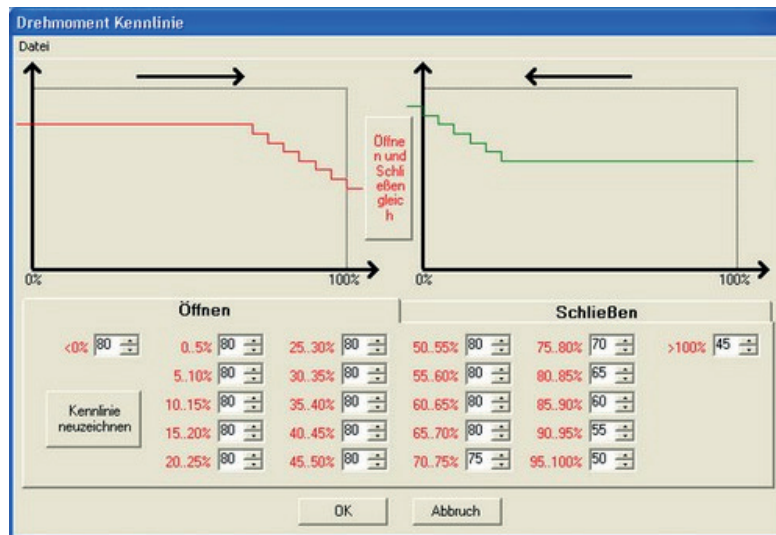

Table 23. Characteristic Curves Parameter Group

	Menu Item	Sub Menu Item	Poss. Setting	Notes / Comments
P17.1	Characteristic	Torque Open	Off	The torque characteristic curve is disabled for the OPEN direction
			On	The torque characteristic curve is enabled for the OPEN direction
			Local + Remote only	The torque characteristic curve is enabled for the OPEN direction only in LOCAL and REMOTE mode (while disabled in the EMERGENCY mode)
P17.2	Characteristic	Torque Closed	Off	The torque characteristic curve is disabled for the CLOSED direction
			On	The torque characteristic curve is enabled for the CLOSED direction
			Local + Remote only	The torque characteristic curve is enabled for the CLOSED direction only in LOCAL and REMOTE mode (while disabled in the EMERGENCY mode)

7.17 Parameter Group: Identification (option)

This option allows entering further custom-identification parameters

Table 24. Identification Parameter Group

	Menu Item	Sub Menu Item	Poss. Setting	Notes / Comments
P18.1	Identification	PPS number	15-digit	Used to enter a PPS number. This is displayed in the bottom line. CAUTION: point P20.5 must be set to 0.

7.18 Parameter Group: System Parameters (locked)

Used for actuator configuration and not available for customers.

7.19 Parameter Group: Miscellaneous

Table 25. Miscellaneous Parameter Group

	Menu Item	Sub Menu Item	Poss. Setting	Notes / Comments
P20.1	Miscellaneous	Language	0: German	Defines the menu language
			1: English	
			2: Russian	
			3: Czech	
			4: Spanish	
			5: French	
			6: Italian	
			7: Danish	
P20.2	Miscellaneous	Rotate display	no	Default setting
			yes	Rotates the display by 180° Warning: The operation of the control switch and the selector switch keeps the same.
P20.3	Miscellaneous	Load configuration	Customer conf. -	Actuator parameters, excluding points P1.1 to P1.6, will be overwritten with customer parameters.
			Customer conf. +	Actuator parameters, including points P1.1 to P1.6, will be overwritten with customer parameters.
			Backup parameters. -	Actuator parameters, excluding points P1.1 to P1.6, will be overwritten with factory parameters.
			Backup parameters. +	Actuator parameters, including points P1.1 to P1.6, will be overwritten with factory parameters.
P20.4	Miscellaneous	Save configuration	Customer conf.	Stores all parameters in the customer configuration.
P20.5	Miscellaneous	Info line	[0] - 31	The fourth line of the display shows various diagnostic values.
P20.6	Miscellaneous	Infrared	Off (0)	The infrared connection is disabled
			On (1)	The infrared connection is activated for about 3 minutes

Section 8: Status Area

The status area presents current process and diagnostic data. Here data is read-only. To access the status area, move the control switch in the direction where the selector switch should be in the neutral position or in the remote position.

The status area is divided into 2 sub-areas:

- Status
- History

8.1 Status

8.1.1 Status – Binary Outputs

Display of binary outputs: The display shows output control as opposed to output status, i.e. the supply of the binary outputs is ignored. A switched output is represented by 1.

Figure 55 Binary Output Display

SMARTCON	
S 1	Bin. Outputs
1 2 3 4 5 6 7 8	
1 1 0 0 0 0 0 0	

Display Overview:

1. Output Number
2. Signal (0 = Low; 1 = High)

8.1.2 Status – Binary Inputs

Display of binary inputs: A set input is represented by 1.

Figure 56 Binary Input Display

SMARTCON	
S 2	Bin. Inputs
1 2 3 4 5	
0 0 0 0 0	

Display Overview:

1. Input Number
2. Signal (0 = Low; 1 = High)

8.1.3 Status – Analogue Values

Display of analogue values: Input 1 (In1) is used by the positioner as the setpoint; Input 2 (In2) serves as an external value for the optional PID controller. In the analogue output (out), only the control signal is shown, regardless of whether the output current actually flows or not (interruption of the current loop).

Figure 57 Analogue Status Display

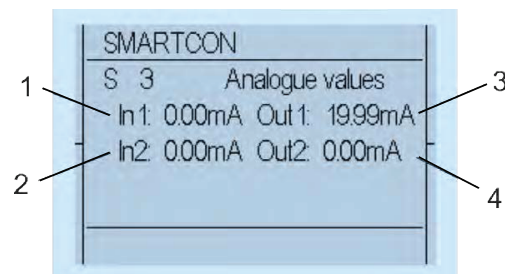

Display Overview:

1. Input 1
2. Input 2
3. Output
4. All values in mA

8.1.4 Status – Absolute Values

This status displays the absolute position of the actuator.

Figure 58 Absolute Value Display

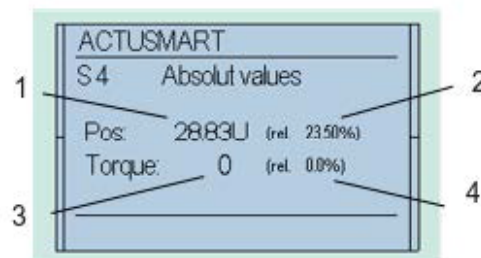

Display Overview:

1. Absolute value of the position unit
2. Relative value of the position unit
3. Absolute value of the torque unit
4. Relative value of the position unit (calibrated in factory)

8.1.5 Status – Firmware

Figure 59 Firmware Status Display

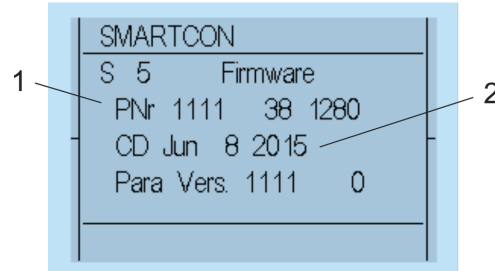

Display Overview:

1. Firmware
2. Firmware date

8.1.6 Status – Serial Number

Figure 60 Serial Number Display



Display Overview:

1. Serial number of the control unit
2. Serial number of the actuator
3. Serial number of electronics

8.1.7 Status - Meter Readings

Figure 61 Meter Readings Status Display

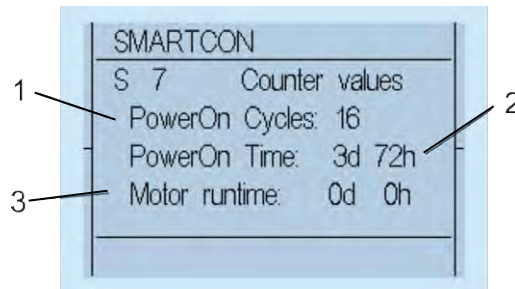

Display Overview:

1. Power-on cycles
2. Operating hours
3. Engine duration

8.2 History

History shows the last 20 history entries. In addition to the plain text entry, the time since the last history entry is also provided.

Please note that the actuator can only calculate time if energised. For error analysis, please refer to Section 12.1.

Section 9: Infrared Connection

For easier communication and better visualization of the menu options, the unit provides an infrared port for connection to a PC.

The required hardware (connection cable to the PC's RS-232 or USB connectors) and the corresponding software are available as options.

The SMARTTOOL software, in addition to communication with the actuator, allows the management of multiple actuators to transfer the configuration to different actuators.

This approach can greatly simplify operation.

Please refer to the SMARTTOOL software operating instructions manual for further information.

During operation, ensure that the IR interface surface is protected from strong disturbances which may compromise the communication.

Before mounting the infrared adapter, clean the surface of the infrared interface with a damp cloth.

When the infrared interface is enabled, it is indicated by Light-emitting (LED) (see Figure 62). The infrared interface can be enabled in the menu item P20.6.

Figure 62 LED IR Indicator

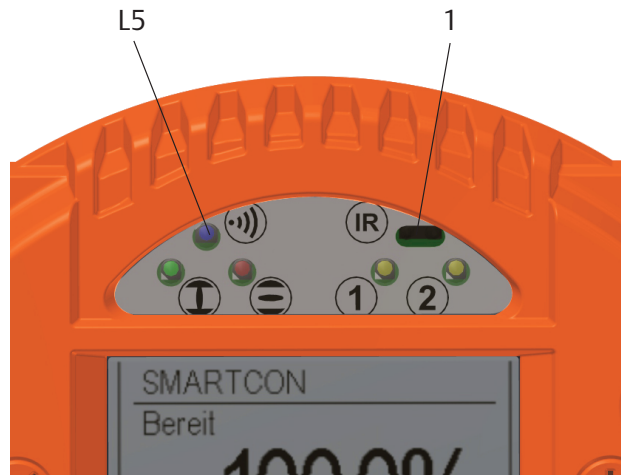

Display Overview:

1. Infrared connection

Section 10: Bluetooth Link

In addition to the infrared interface, it is also possible to configure the Control System using a Bluetooth interface. Software required for Android equipment is available as an option.

In addition to communication with the actuator, the Android software also enables management of multiple actuators, allowing easy transfer of parameter sets to various actuators.

This approach can simplify commissioning significantly.

When the Bluetooth interface is enabled, this is indicated by the light-emitting diode L5 (see Figure 62). The Bluetooth interface can be enabled in menu item P20.6.

Section 11: Maintenance

Maintenance work on open actuators may only be conducted if the actuators are de-energized. Reconnection during maintenance is strictly prohibited.

NOTE:

Work on the electrical system or equipment must be carried out only in accordance with electrical regulations by a qualified electrician or by specially instructed personnel under the control and supervision of a qualified electrician.

⚠ CAUTION

For explosion-proof actuators, it is necessary before opening the cover to wait a certain time after switching off, see explosion protection sticker (Figure 63). Following times are specified for the actuators.

- CM03: 5 min
 - CM06: 10 min
-

Figure 63 Explosion protection sticker



Display Overview:

1. Explosion protection sticker

Actuators are ready for use after installation. By default, the actuator is delivered filled with oil. On-going monitoring:

- Beware of increased running noise. During long downtime periods, operate the actuator at least every 3 months.
- For actuators with output types A, B and C according to DIN 3210-A, B1, B2 and C according to DIN ISO 5210, re-lubricate grease fittings at least every 6 months (see Section 14).

Actuators are ready for use after installation. By default, the actuator is delivered filled with oil.

On-going monitoring:

- Beware of increased running noise. During long downtime periods, operate the actuator at least every 3 months.
- For actuators with output types A, B and C according to DIN 3210-A, B1, B2 and C according to DIN ISO 5210, re-lubricate at least every 6 months on existing grease fittings (see Section 14)

Actuators are designed for installation in any position (see Section 2.5). Therefore, the main body is not equipped with a level indication or a drain plug. The replacement of the lubricant from the main body must be performed via the handwheel.

Every approx. 10,000-20,000 hours (about 5 years - 15), depending on the workload, you must:

- Change Oil
- Replace seals
- Check all roller bearings and the worm-wheel assembly and replace if necessary
- Check our lubricants table for recommended oils and greases. (see Section 14)

⚠ CAUTION: REGULAR CHECK OF CABLE GLANDS

Check the cable glands at regular intervals (annually) for tightness of the cables and retighten if necessary.

Section 12: Troubleshooting

Upon warning or error, the bottom line of the display will show the corresponding, plain text description. This event will also be entered into the history (see Section 8.2)

12.1 Error List

Each error has a unique error number. Each error also has its separate “OK” message in the history after the fault has gone.

Table 26. Errors and Indication

Error	LED indicators	Description
#3: Mot. temp. warn. #19: Mot. temp. warn. OK	L4 flashes slowly	The motor temperature is in the critical range although the actuator remains fully functional.
#4: Mot. temp. trip. #20: Mot. temp. OK	L4 is off	Overtemp in motor, fault on Basis or BLDC, On Basis: loss of main power (3x400V) or cable break between CSC and motor; on BLDC: cable break between BLDC and motor.
#5: Phase sequ. error #6: Phase sequ. OK	L4 is off	Cause on Basis: Active phase sequence detection on single phase actuators, loss of main power while connected to external 24VDC auxiliary voltage, or loss of phase L2.
#7: Ready	L4 is off	Written to the history after all errors are gone.
#8: Power On	L4 is off	Is written to the history after power on the actuator, even if there are some errors.
#9: Power supply error #21: Power supply OK	L4 is off	No power supply to the power electronics (when the controller is powered from the auxiliary power input). Defect of power electronics – please contact the manufacturer.
#11: Failsafe error #12: Failsafe OK	L4 is off	Communication error between Failsafe board and Logic, loss of external 24 V Failsafe Voltage, or overtemp. on Failsafe brake.
#13: Manual override #14: Manual override off	L4 is off	Manual override on Failsafe activate (visible in status S4), cable/switch broken.
#17: Travel error #18: Travel OK	L1 and L2 lit up L4 flashes fast	The travel unit is outside the permitted range (potentiometer fault on Basis), cable broken, or multiturnsensor calibration lost on CM – please contact the manufacturer.
#22: Torque error #23: Torque OK	L3 flashes fast L4 is off	Potentiometer fault on Basis, or cable broken.
#24: Bus error #25: Bus OK	L4 flashes slowly	No communication with the optional bus system.
#26: Bus Watchdog #27: Bus Watchdog OK	L4 flashes slowly	Watchdog for bus communication has reacted.
#28: Undervoltage #29: Voltage OK	L4 is off	Reserved for future use

#32: Internal Comm. L> error #33 Internal Comm. L> OK	L4 is off	Communication error between Logik and Basis/BLDC, cable broken between boards, or board defect.
#34: Internal Comm. D> error #35: Internal Comm. D> OK	L4 is off	Communication error between Display and Logik, cable broken between boards, boards defect, or firmware update on Logik not properly done.
#36: Failsafe not ready #37: Failsafe ready	L4 flashes slowly	Failsafe voltage OK and Failsafe not initialized (LUS not tensioned).
#38: Battery low #39: Battery OK	L4 is off	Battery on Display board is empty, loss of time/date or counter values possible.
#44: Inverter error Para #45 Inverter OK Para	L4 is off	BLDC parameter error.
#46: Analog Input 1 Failure #47: Analog Input 1 OK	L4 flashes slowly	SRG active, Positioner live zero detection activated, no setpoint value recognized.
#48: Analog Input 2 Failure #49: Analog Input 2 OK	L4 flashes slowly	Ext. setpoint active, Ext. setpoint live zero detection activated, no Ext. setpoint value recognized

Table 27. Errors in case of special types

Error	LED indicator	Description
#30: Oil level low #31: Oil level OK	–	Binary input on Basis board or switch faulty.
#40: Oil pressure low #41: Oil pressure OK	–	Analog input (4 - 20 mA) on Basis board faulty.
#42: Motor protection #43 Motor protection OK	–	Binary input on Basis board or switch faulty.

Section 13: Fuses

The logic board of the controller cover (see Figure 64) features two miniature fuses for the control lines.

Figure 64 Fuse Location

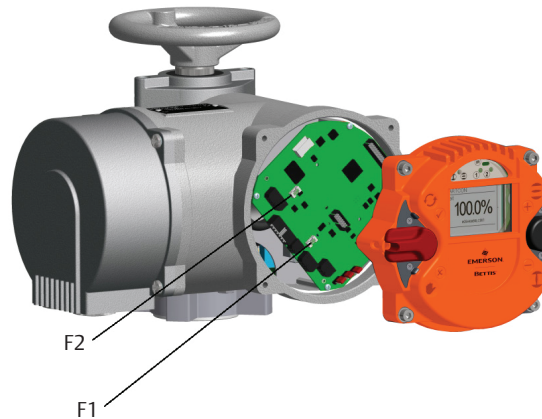

Display Overview:

1. Fuse F10a for the binary outputs
2. Fuse F10b fuse for auxiliary supply

Table 28. Fuses on the Logic Board

Fuse	Value	Manufacturer	List of spare parts
F10a	1AT	Littelfuse 454 NANO2 Slo-BloQR träge	C302c
F10b	4AT	Littelfuse 454 NANO2 Slo-BloQR träge	C302d

NOTE:

The frequency inverter is protected by an input fuse and the explosion-proof version also has a thermal fuse. (see Section 2.7.3).

Section 14: Lubricant Recommendation and Requirements

14.1 Main Body: -25 to +60°C

Operating oil: DIN 51 517-CLP-HC
i.e. fully synthetic high-performance gear oils based on poly- α -olefins (PAO)

- Viscosity class: 320 ISO VG
- Lubricant requirement: 0,25 Lt

14.2 Output Type A and Spindle Drives (Linear Actuators) -40 to +85°C

Grease DIN 51862- G 1 -G
i.e. water repellent complex grease on Al-soap base with high resistance to acids and alkalis

- Penetration 0,1 mm: to 265
- Dropping point: about 260°C
- NLGI - Klasse: 1
- Acid-free, little or no water-reactive

14.3 Basic Lubricant Service Interval

The functionality and durability of the lubricant is contingent upon operating conditions. It is advised that the Bettis actuators be serviced by Emerson 10 years after delivery.

Table 29. Reduction Factors

Operating condition (s)	Definition	Reduction factor (multiplier)
Duty time DT	(Total engine running time)	
Extremely high DT	over 1250 hours/year	0,5
High DT	over 500 hours/year	0,7
Extremely low DT	less than 0,5 hours/year	0,8
Ambient temperature	(permanent or long-term)	
Extremely changeable	between -10 and +50 °C	0,5
Extremely high	above +50 °C	0,7
Extremely low	below - 25 °C	0,9
Output speed	(on actuator main shaft)	
High speed	over 80 U/min	0,8
Utilisation	(relative to rated power)	
Very high	über 90%	0,8
High	between 80 and 90%	0,9

Application example:

Extremely low DT + extremely low ambient temperature + high speed + 87% utilization

=> $0,8 \times 0,9 \times 0,8 \times 0,9 = 0,51$ reduction factor

Lubrication maintenance interval => 10 years $\times 0,51 = 5,1$ years (62 months).

CAUTION: LUBRICATE PROPERLY

This calculated maintenance interval does neither apply to the maintenance of output type A (threated bushing) units nor to the maintenance of linear and spindle drive units.

These units must periodically lubricated (at least every 6 months) via the grease nipples (see Section 14.3)

During maintenance of our actuators, remove and replace old grease with new one.

Mixing of different lubricant types is NOT permitted.

Quantities needed for lubricant service are listed in Section 14.

Section 15: Training

CAUTION: CONTACT FOR SUPPORT

If you experience problems during installation or upon adjustments on site, please contact Emerson, Texas at +1 281 477 4100 or to prevent any operational errors or damage to the actuators. Emerson recommends engaging only qualified personnel for installation of RTS CM Compact Series actuators. Upon special request of the client, Emerson can conduct training on the activities listed in this operating manual at the factory of Emerson.

Section 16: Technical Data and Certifications

16.1 Binary Outputs

Figure 65 Control Unit

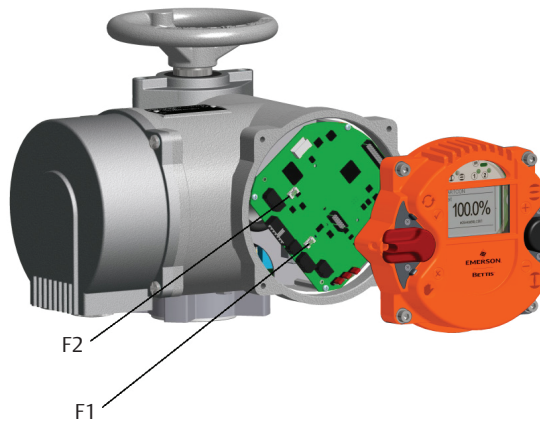

Figure 66 Logic Board

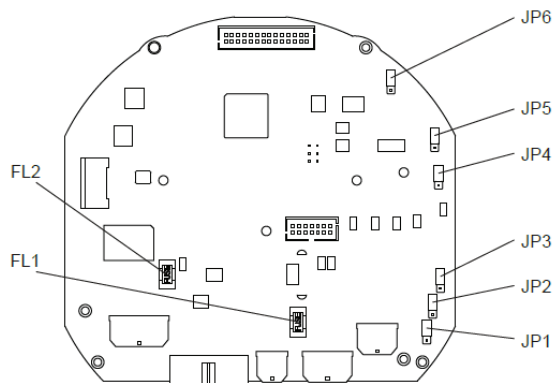

Table 30. Binary Outputs

Characteristic	Value
Count	8
Power supply	24VDC nominal range: 11 - 35VDC (either from internal or external)
Max voltage drop at set output	1 V
Output voltage at non-set output	<1 V
Maximum current per output:	500mA (short circuit proof)
Maximum permissible total current for all outputs:	4A
Fuse (Fuse F2, see Figure 68)	4 A slow (Littelfuse 454 NANO2 Slo-Blo®)

Binary outputs with external supply are separated from other controllers via optocouplers.

16.2 Binary Inputs

Table 31. Binary Inputs

Characteristic	Value
Count	5
Nominal voltage	24VDC towards common ground
Threshold voltage for input set	>10 V max. (8.5V typ.)
Threshold voltage for input not set	<10 V
Maximum voltage:	30VDC
Current consumption at 24VDC	10.5mA typ.

Binary inputs are separated from other controllers via optocouplers.

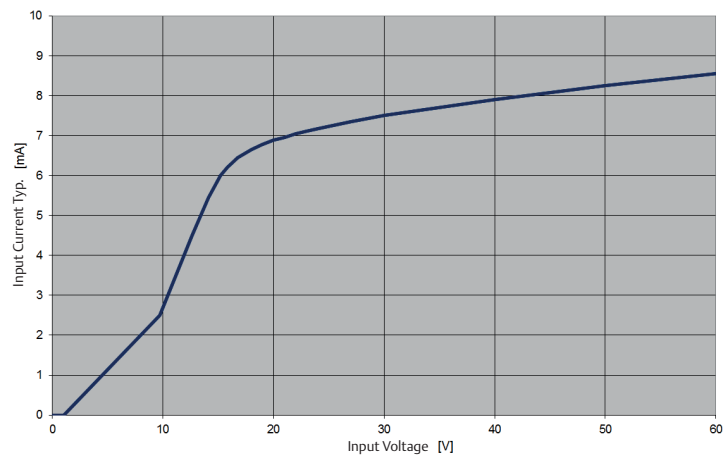
Figure 67 Current/Voltage Relation

Jumpers JP1 - JP3 can be used to interconnect the binary inputs to groups with separate earths.

Figure 68 5 Inputs with Same Common

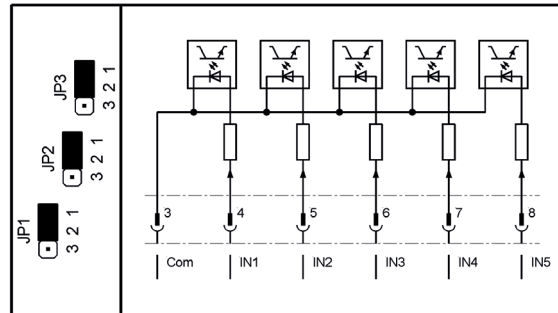

Figure 69 2 Separated Groups of 2 Inputs with Same Ground Input IN3 is Disabled.

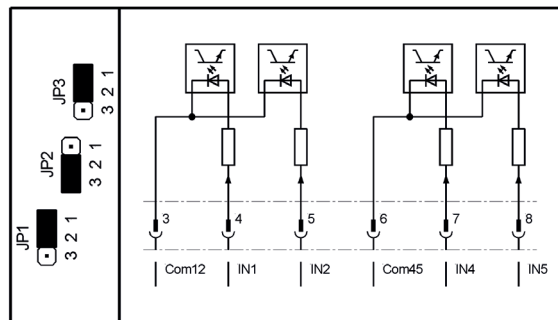

Figure 70 3 Separated Inputs; Inputs IN2 and IN4 are Disabled.

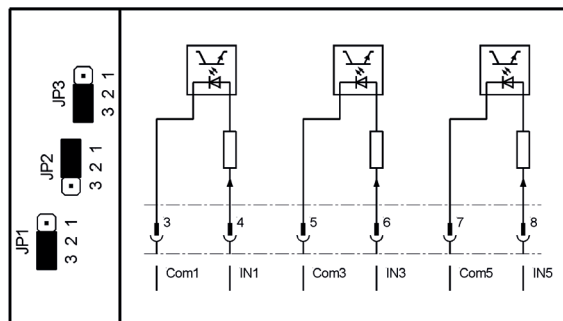

Figure 71 3 Inputs with Same Common and 1 Separated Input. Input IN4 is Disabled.

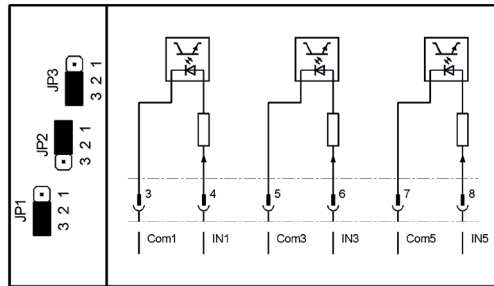

Figure 72 1 Separated Input and 3 Inputs with Same Common. Input IN2 is Disabled.

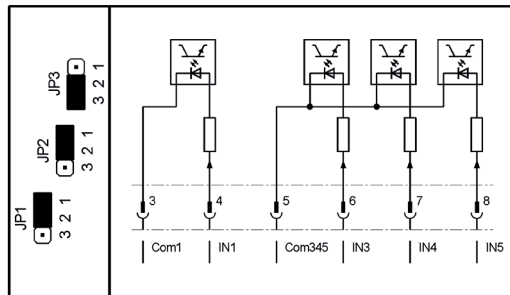

Figure 73 5 inputs with common = "-" using external 24V

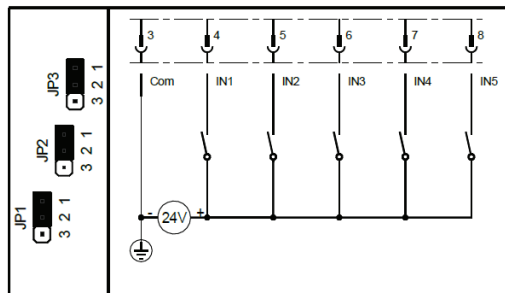

Figure 74 5 inputs with common = "-" using internal 24V (e.g. for dry contacts)

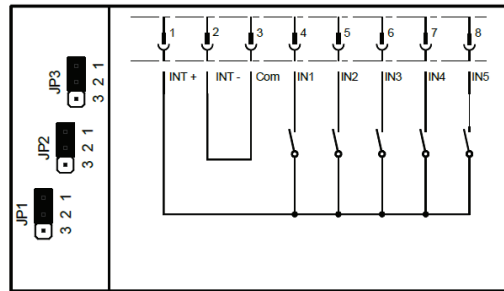

Figure 75 3 separated inputs using 3 separated external 24V

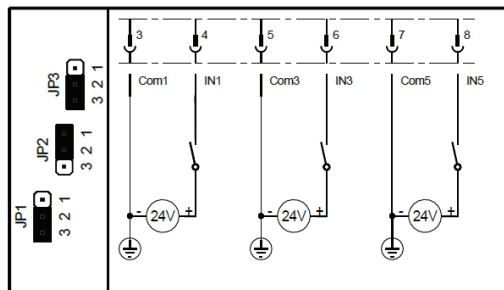
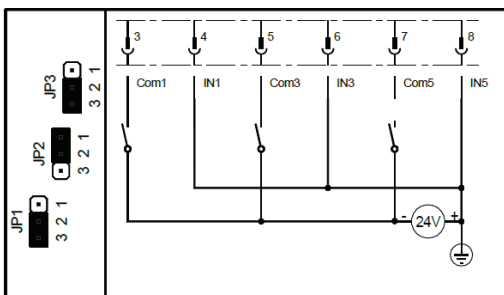

Figure 76 3 separated inputs using 3 separated external 24V



16.3 Analog Inputs

Table 32. Input 1: Setpoint Value

Characteristic	Value
Current range:	0-25mA
Resolution:	14Bit
Accuracy:	0,5%
Input resistance:	60 Ohm

Analog input 1 is electrically isolated from the rest of the electronic system.

**Table 33. Input 2: External Actual Value
Only in Conjunction with the PID Controller**

Characteristic	Value
Current range:	0-20,8mA
Resolution:	12Bit
Accuracy:	0,5%
Input resistance:	120 Ohm

Jumper JP6 can be used to switch analog input 2 from a passive input (default) to an input with internal 24 V power supply (for 4. . . 20 mA, two-wire transmitters).

NOTE:

The analog input 2 is referenced to common of the electronic system and the auxiliary power supply.

16.4 Analog Output

Table 34. Analog Output

Characteristic	Value
Current range:	0-20,8mA
Resolution:	12Bit
Accuracy:	0,5%
Input resistance:	600 Ohm

The analog output is galvanically isolated from the rest of the electronic system.
Jumper JP4 can be used to switch the analog output from an active power source (default) to a current sink, allowing the output to simulate a 4 - 20 mA, two-wire transmitter.

Figure 77 Current Source

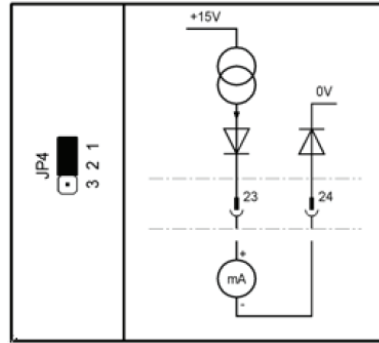
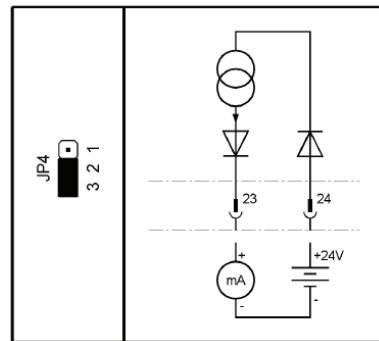

Figure 78 Current Sink



Ground potential is the potential of the control unit and the auxiliary supply.

16.5 Auxiliary Voltage Input and Output

Table 35. Auxiliary voltage input and output

Characteristic	Value
Input voltage range (auxiliary voltage input)	20 - 30VDC
Maximum current consumption (auxiliary voltage input)	500mA
Maximum current consumption in power-save mode (auxiliary voltage input)	120mA
Output voltage (auxiliary voltage output)	typ. 23 V
Maximum output current (auxiliary voltage output)	200mA
Resistance of common ground vs. earth	typ. 500 k Ohms
Resistance of common ground vs. earth (floating version)	> 10M Ohms
Capacitance of common ground vs. earth	typ. 100 nF
Maximum allowed voltage of common ground vs. earth	max. 40 Vs
Fuse (Fuse F1, see Figure 64)	1 A slow (Littelfuse 454 NANO2 Slo-Blo R)

Ground potential is the common ground of the controller and the analog inputs and outputs.

The auxiliary voltage output can be set in menu P6.5 (see Section 7.5).

The power-save mode is defined as follows:

- No power supply (the controller is powered exclusively through the 24V auxiliary voltage input).
- The backlight of the LCD display switches off automatically.
- No additional hardware options included (Profibus Interface, DeviceNet interface, relay board, etc).
- Binary outputs and the mA output are not enabled; when activating, the respective currents must be added to the total current consumption.

16.6 Connections

16.6.1 Connections for non explosion-proof version

Table 36. Non-Explosion-Proof Connections

Connection	Value
Power/motor:	Industrial plug with 6 pins Screw connection 16A, max. 2,5mm ² , AWG14
Control signals	Industrial plug with 24 pins Screw connection 16A, max. 2,5mm ² , AWG14

Optionally, contacts are available in crimp or cage clamp designs.

16.6.2 Connections for explosion-proof version

Table 37. Explosion-Proof Connections

Connection	Value
Power/motor:	Terminals with screw connection 16A, 0,5 - 4mm ² , AWG20 - AWG12
Control signals	Terminals with screw connection 4A, 0,5 - 2,5mm ² , AWG20 - AWG14

16.7 Miscellaneous

Table 38. Miscellaneous

Characteristic	Value
Ambient temperature	
Non explosion-proof version	-25 ... +60°C
Explosion-proof version	-20 ... +40°C (according EN 60079-0)
Ex version with extended temperature range	-40 ... +60°C
Protection according to EN 60529:	IP67
Standard color	RAL7024

TYPE		CM-32	CM-64
Adjustable Max Torque	max.lbs.ft (Nm)	23 (32)	47 (64)
Min Torque	max.lbs.ft (Nm)	5.9 (8)	11.8 (16)
Modulating Torque	max.lbs.ft (Nm)	12 (16)	23.6 (32)
Adjustable Speed Range	RPM	2.5 up to 70	
Adjustable Turns	max.	0.25 up to 100 with travel sensor non-intrusive through switches adjustable	1 up to 300 with travel sensor non-intrusive through switches adjustable
Operation Mode	On/Off duty	S2-15 minutes	
	Modulating duty	S9	
Manual Operation		Switching free, overlaid, without lever	
VALVE-MOUNTING			
Flange		F7/F10 F10 (ISO 5210)	
Output Shafts		A / Am	
Max Valve Stem Diameter	in (mm)	0.78 (20)	1.25 (32)
OPERATING CONDITIONS			
Ingress Protection		IP66 (NEMA 4x), IP67 (NEMA 6) , IP68	
Ambient Temperature		-40°C to + 60°C	
HOUSING			
Material		Aluminum	
Enclosure		Weather-proof / Explosion-proof (optional)	
Certifications		1ph, 24VDC – CSA NEC 500 / NEC505, ATEX, IECEx, LVD 3ph - ATEX	1ph, 24VDC – CSA NEC505, ATEX
Coating		High quality two component polyurethane paint system-C3 ISO12944-5	
Approximate Weight	lbs. (kg)	20.9 (9.5)	30.8 (14)
MOTOR			
Isolation Class		Brushless DC Motor Isolation Class F, max. 155°C permanent temperature	
Power Supply	V	24 - 230 VDC *, Single Phase 115V - 230V +/-10%, Three Phase 380V - 480V +/-10% (*restrictions apply)	
Current Consumption	A	2.25	
Power	W	250	
ACTUATOR CONTROL			
Electronic with Frequency-Technology		Integrated processor control unit with frequency-technology for variable speed control	
Control Unit			
Control Elements		<ul style="list-style-type: none"> · Selector switch LOCAL - OFF- REMOTE · Control switch OPEN - STOP - CLOSE contact less sensor technology · Language independent symbols 	
Control Functions		<ul style="list-style-type: none"> · Full stroke test · Partial stroke test 	
Local Display		Backlit LCD display, can be rotated in 90 degree steps	
LEDs		Programmable LED's for operation, readiness, warning and error messages	
Communication		Infrared communication interface for programming and saving operation data	
Control			
Inputs		<ul style="list-style-type: none"> · 5 configurable binary (discrete) control inputs: OPEN - STOP - CLOSE - EMERGENCY OPEN - EMERGENCY-CLOSE · Power supply: 24VDC (max. 30VDC) - current consumption with 24VDC: typical 5mA · The common ground of the inputs is optical isolated from the rest of the electronics · Analog control 4-20 mA (2 wire) 	
Status Indication			
Outputs		<ul style="list-style-type: none"> · 8 configurable binary (relay) outputs: READY - OPEN - CLOSE - RUNNING OPEN - RUNNING CLOSE - TORQUE - LOCAL - REMOTE · Power supply 24VDC +/- 6V (per actuator or through control system) · Max. allowed current per output: 50mA (short-circuit-proof) · Max. allowed current for all outputs with power supplied by actuator: 150mA · Max. allowed current for all outputs with power supplied by control system: 250mA · All outputs are optical isolated if power is supplied by control system 	
Voltage Input and Output			
Power Supply - External		<ul style="list-style-type: none"> · Input power range: 20-30VDC max current consumption 320mA or 100mA in current save mode · Status indication also in case of a main power supply failure 	
Power Supply - By Actuator		<ul style="list-style-type: none"> · Output voltage: typical 22V max output current 150mA · Reference ground is the common ground of the control unit and of the analog inputs and outputs 	
Functions			
Standard		<ul style="list-style-type: none"> · Switch-off mode adjustable: travel or torque dependent to valve type · Torque/Force adjustable: 25-100% of max torque/force · 4 intermediate positions between 0 and 100% in both directions parametrizable · Step-mode operation with adjustable STEP-START, STEP-STOP, RUNNING, and BREAK TIME in both directions · PID positioner for 2 input signals 0/4-20mA (setpoint, external actual value) · Writing and reading protection via password · Multilingual display indication: German, English, Czech, Russia and Danish · Status indication of binary inputs and outputs and of the analog signals on LCD display · Data logging for analysis and service · History data for service planning and error analysis · Motor protection with thermo switches in motor 	
Electric connection			
Cable Entries		3 metric threaded holes for cable glands: Weather-proof 1xM40, 1xM32, 1xM25 / Explosion-proof 1xM40 + 2xM20	
OPTIONS			
Digital Communications		Modbus RTU, ProfiBus, ProfiNet, Foundation FieldBus HART Platforms	
Relay Board		250 VAC, 2A with 4 outputs	
Analog Position Transmitter		0/4-20mA (2-wire)	
Coating		4 layer with Epoxy under coat for increased corrosion protection – C5-I, C5-M ISO12944-5	

World Area Configuration Centers (WACC) offer sales support, service, inventory and commissioning to our global customers. Choose the WACC or sales office nearest you:

NORTH & SOUTH AMERICA

19200 Northwest Freeway
Houston TX 77065
USA
T +1 281 477 4100

Av. Hollingsworth
325 Iporanga Sorocaba
SP 18087-105
Brazil
T +55 15 3413 8888

ASIA PACIFIC

No. 9 Gul Road
#01-02 Singapore 629361
T +65 6777 8211

No. 1 Lai Yuan Road
Wuqing Development Area
Tianjin 301700
P. R. China
T +86 22 8212 3300

MIDDLE EAST & AFRICA

P. O. Box 17033
Jebel Ali Free Zone
Dubai
T +971 4 811 8100

P. O. Box 10305
Jubail 31961
Saudi Arabia
T +966 3 340 8650

24 Angus Crescent
Longmeadow Business Estate East
P.O. Box 6908 Greenstone
1616 Modderfontein Extension 5
South Africa
T +27 11 451 3700

EUROPE

Holland Fasor 6
Székesfehérvár 8000
Hungary
T +36 22 53 09 50

Strada Biffi 165
29017 Fiorenzuola d'Arda (PC)
Italy
T +39 0523 944 411

For complete list of sales and manufacturing sites, please visit www.emerson.com/actuationtechnologieslocations or contact us at info.actuationtechnologies@emerson.com

www.emerson.com/bettis

©2019 Emerson. All rights reserved.

The Emerson logo is a trademark and service mark of Emerson Electric Co. Bettis™ is a mark of one of the Emerson family of companies. All other marks are property of their respective owners.

The contents of this publication are presented for information purposes only, and while every effort has been made to ensure their accuracy, they are not to be construed as warranties or guarantees, express or implied, regarding the products or services described herein or their use or applicability. All sales are governed by our terms and conditions, which are available on request. We reserve the right to modify or improve the designs or specifications of our products at any time without notice.

BETTIS™

