



TEL-TRU MANUFACTURING COMPANY PRESSURE GAUGES



PRESSURE EQUIVALENTS

PSI	IN. HG	MM HG.	KG/CM ²	FT. WATER	IN. WATER	ATM.	KPA	BARS
1	2.0442	51.924	.07031	2.3118	27.735	.06805	6.8948	.06894
.48920	1	25.401	.03439	1.1309	13.568	.03329	3.3864	.03386
.01926	.03937	1	.00135	.04453	.53418	.00131	.13332	.001333
14.223	29.075	738.51	1	32.881	394.57	.96784	98.068	.98068
.43256	.88426	22.460	.03041	1	12.000	.02943	2.9890	.02989
.03606	.07368	1.8721	.00254	.08333	1	.00245	.24908	.00249
14.696	30.042	763.07	1.0332	33.974	407.69	1	101.325	1.01325
.14504	.29530	7.5006	.01019	.33456	4.0147	.009869	1	.01000
14.504	29.530	750.06	1.0197	34.456	401.47	.98692	100	1

CORROSION CHART

The media being measured must be compatible with the wetted parts of the pressure instrument. This is a simplified chart and assumes the media temperature is below 200°F except for the media with a "*" which must be below 100°F. These recommendations are only a guide as service life may be dependent on other conditions beyond our control.

MEDIA APPLICATION	Pressure Instrument Material				MEDIA APPLICATION	Pressure Instrument Material				MEDIA APPLICATION	Pressure Instrument Material				
	Brass or bronze	Steel	AISI 316 st st	Monel		Diaphragm seals**	Brass or bronze	Steel	AISI 316 st st		Monel	Diaphragm seals**	Brass or bronze	Steel	AISI 316 st st
Acetone*	✓		✓	✓	Ferric Sulfate <10%			✓		Sodium Carbonate <40%			✓	✓	
Acetic Acid <40%					Ferrous Chloride <30%				✓	Sodium Chromate <60%	✓	✓	✓	✓	
Acetic Anhydride				✓	Ferrous Sulfate <50%				✓	Sodium Cyanide*		✓	✓		
Acetylene (Dry)		✓	✓		Fluorine Gas (Dry)			✓	✓	Sodium Hydroxide <40%			✓	✓	
Acrolein 100%				✓	Formaldehyde <95%			✓	✓	Sodium Hypochlorite <25%					✓
Air	✓	✓	✓	✓	Formic Acid*				✓	Sodium Phosphate, Tri <60%	✓	✓	✓	✓	
Alcohol, Ethyl	✓	✓	✓		Freons	✓	✓			Sodium Silicate <50%		✓	✓	✓	
Alum. Chloride >10%				✓	Furfural <10%				✓	Sodium Sulfide <50%					✓
Alum. Sulfate 10-50%			✓		Gasoline			✓		Stannous Chloride <10%			✓		
Ammonia Gas (Dry)		✓	✓		Glycerine >99%	✓	✓	✓		Steam (Use siphon)	✓	✓	✓	✓	
Ammonium Chloride <40%				✓	Hydrobromic Acid				✓	Stearic Acid			✓	✓	
Ammonium Nitrate <50%			✓		Hydrochloric Acid				✓	Sulfur Dioxide (Dry) >99%					✓
Ammonium Sulfate <60%				✓	Hydrofluoric Acid				✓	Sulfur Trioxide (Dry) >99%					✓
Aniline >99%			✓		Hydrofluosilic Acid				✓	Sulfurous Acid					✓
Argon	✓	✓	✓	✓	Hydrogen ²	✓	✓			Tannic Acid <80%	✓	✓	✓	✓	
Beer			✓		Hydrogen Peroxide <50%	✓	✓			Tartaric Acid <50%	✓	✓	✓	✓	
Benzidine >99%				✓	Kerosene	✓	✓	✓	✓	Tin Chloride (ous) <10%				✓	
Benzene <50%			✓	✓	Lactic Acid <70%*			✓		Toluene >99%	✓	✓	✓	✓	
Benzoic Acid <70%			✓		Magnesium Chloride <40%				✓	Turpentine >98%	✓	✓	✓	✓	
Boric Acid <25%			✓		Mercuric Chloride <60%	✓	✓			Water	✓	✓	✓	✓	
Bromine (Dry)				✓	Mercury >99%				✓	Whiskey				✓	
Butane	✓	✓	✓	✓	Milk			✓		Zinc Chloride <25%					✓
Butyric Acid <10%			✓		Naphtha >99%	✓	✓	✓	✓	Zinc Sulphate <40%					✓
Calcium Chloride <80%				✓	Naphthalene >99%			✓							
Calcium Hydroxide <50%				✓	Nickel Chloride >99%				✓						
Carbon Dioxide	✓	✓	✓	✓	Nitric Acid <95%*			✓							
Carbon Monoxide >99%	✓	✓	✓	✓	Nitrogen	✓	✓	✓	✓						
Chlorine (Dry)				✓	Oleic Acid	✓	✓								
Chlorine (Moist)*				✓	Oxalic Acid*				✓						
Chloroform (Dry)			✓	✓	Oxygen (Gas) ¹	✓	✓	✓	✓						
Chromic Acid				✓	Palmitic Acid >99%*			✓	✓						
Citric Acid 10-50%			✓		Phosphoric Acid <80%*			✓							
Corn Oil			✓		Picric Acid <10%			✓							
Crude Oil (Sour)					Propane (Dry)	✓	✓	✓							
Crude Oil (Sweet)			✓	✓	Sea Water (Flowing)				✓						
Ethyl Acetate	✓	✓	✓	✓	Silver Nitrate <70%				✓						
Ethylene Oxide >99%	✓	✓	✓	✓	Sodium Bicarbonate <20%			✓	✓						
Ferric Chloride <40%				✓	Sodium Bisulfate <30%				✓						

¹ Bronze and AISI 316 stainless steel are acceptable for oxygen service, provided the instrument has been cleaned for service and is free from oil.

² Over 1000 psi—entire system must be AISI 316 stainless steel.

*Over 1000 psi—entire system must be stainless steel.

**Any standard Bourdon tube or bellows material may be used in conjunction with a diaphragm seal (with bellows use a Viton or Kalrez diaphragm), but the gauge selection should take into consideration the corrosive environment in which it is to operate.

GENERAL INFORMATION

All gauge components should be selected based upon knowing the pressure, temperature, and media to prevent misapplication. Improper installation can damage the gauge and/or cause failure resulting in personal injury or property damage. The information in this catalog is offered as a guide to assist in the proper selection of pressure gauges.

The operating conditions of a pressure gauge must always be considered. Pressure gauges should be protected against sudden pressure changes, temperature changes, pulsation and/or mechanical vibration. The proper application of accessories will solve most problems.

Pressure gauges should not be exposed to pressures greater than maximum dial reading. It is recommended that the maximum working pressure be in the middle one-third of the scale range when the pressure being measured is steady pressure. For fluctuating pressures the maximum working pressure should be no more than one-third of the full scale range. Compound ranges are recommended when the pressure to be measured will vary between vacuum and above atmospheric pressures.

Since the measuring element of the pressure gauge may be directly exposed to the measuring media, complete information about the media exposure of the pressure gauge should be obtained to select the proper gauge materials. If the media is corrosive or would solidify in the pressure gauge, a diaphragm seal protector should be used.

The ambient atmosphere in which the pressure gauge is to be installed will have a direct effect on the use, life, and accuracy of the instrument. The atmospheric condition can attack inner gauge components or allow dirt to impair the operation of the pressure gauge.

We suggest that users of pressure gauges refer to American National Standard ANSI B40.1 entitled *Gauges, Pressure and Vacuum Indicating Dial Type - Elastic Element* for guidance in pressure gauge selection. This document may be obtained from the American Society of Mechanical Engineers (ASME), United Engineering Center, 345 East 42nd Street, New York, NY 10017.

TABLE OF CONTENTS

	PAGE
PRESSURE GAUGES	
Model 10 0.5% Process, Solid Front, Blowout Back Case, Receiver, Altitude	2-3
Model 30 1% Stainless Steel Dry or Liquid Filled	4-5
Model 31 1% Stainless Steel Dry or Liquid Filled 4" Solid Front	6-7
Model 32 1.5% Stainless Steel Dry or Liquid Filled	8-9
Model 33 Industrial/Hydraulic	10-11
Model 37 1.5% Low Pressure 4"	12-13
Model 42 0.25% Test	14-15
Model 50 Metal Case Utility	16-17
Model 51 Plastic Case Utility	18
Model 52 4-1/2" Mechanical Contractor	19
Model 55 Low Pressure Diaphragm Utility	20
ACCESSORIES	
Siphons	21
Gauge Cocks	21
Mini Needle Valve	21
Ray Pressure Snubbers™	22-23
DIAPHRAGM SEALS	
Threaded, Flanged, Welded	24-25
Mini Seals	24-25
Sanitary	24-25

TEL-TRU PRODUCT WARRANTY

TEL-TRU products are guaranteed to be free from defective workmanship and material for one (1) year following date of shipment. This warranty does not cover exposure to corrosive materials, erosion, excessive vibration, pressures or temperatures in excess of those recommended, normal wear, or improper handling or storage. Any Tel-Tru product claimed to be defective may be returned to our factory, shipping charges prepaid, after notification to and authorization from us. If, after examination by us, the product is found to be defective under warranty conditions, it will be repaired or replaced free of charge.

When in doubt as to the proper application of any product, you are invited to contact your nearest **TEL-TRU** office or representative for assistance. Suitability of the material and product for the use contemplated by the buyer shall be the sole responsibility of the buyer.

This warranty is in lieu of all other warranties expressed or implied, and all other obligations or liabilities on our part for damages, including but not limited to consequential damages, arising out of the use or misuse of our products, and we neither assume nor authorize anyone to assume for us, any other liability in connection with the sale of our products.

MODEL 10

SOLID FRONT PROCESS PRESSURE GAUGES

Solid front, blowout back, field fillable model, designed for the rugged applications of the process and power industries which must withstand the effects of corrosive atmosphere, vibration or severe pulsations.



SPECIFICATIONS:

Dial Size:	4-1/2"
Accuracy:	±0.5% FS - ANSI Grade 2A
Socket:	316SS or Monel 400
Bourdon Tube:	316SS or Monel
Movement:	SS Rotary Geared with Overload/ Underload Stops
Lens:	Laminated Safety Glass
Pointer:	Micrometer Adjustable
Dial:	Heavy Gage Aluminum
Connection:	1/4" NPT or 1/2" NPT Lower Mount
Range:	See Range Chart
Scales:	psi (metric available)
Fillable:	Rubber membrane included
Blowout Back:	Standard
Protection Standard:	IP65 in accordance with NF EN 60529

MODEL CODES:

Model 10S	316SS Tube and Socket
Model 10M	Monel Tube and Socket

CASE STYLE CODES:

R =	Polypropylene Turret Style Molded Fiberglass Reinforced Thermoplastic
T =	Phenolic Turret Style

Estimated Shipping Weights		
DIAL SIZE	DRY	FILLED
4-1/2"	1 lb. 12 oz.	2 lbs. 12 oz.

➤ AVAILABLE OPTIONS:

- Fill (glycerine standard)
- Plastic Lens
- Other Fluids Available
- Anti-Vibration dampening movement (replaces the need for a fill fluid)
- Restrictor
- Oxygen Cleaning (dry only)
- Calibration Certificate

➤ AVAILABLE CASE STYLES AND DIMENSIONS:

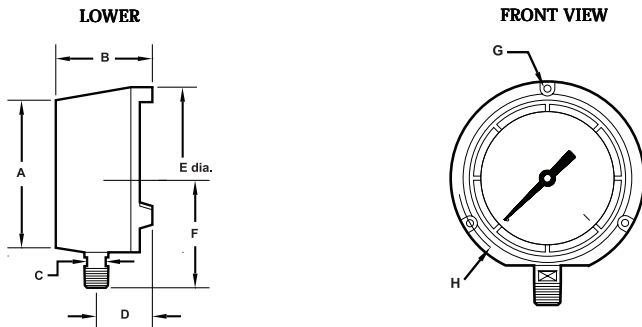

DIAL	A	B	C	D	E	F	G	H
R - CASE 4-1/2"	5.08" (129mm)	1.69" (43mm)	.63" (15,9mm)	1.50" (38mm)	5.83" (148mm)	4.02" (102mm)	.22" (5,6mm)	5.39" (137mm)
T-CASE 4-1/2"	5.08" (129mm)	3.11" (79mm)	.63" (15,9mm)	1.67" (42,5mm)	5.83" (148mm)	4.02" (102mm)	.22" (5,6mm)	5.39" (137mm)



Tel-Tru Manufacturing Company
 408 St. Paul Street, Rochester, New York 14605 USA
 Phone: 585.232.1440 • 800.232.5335 • Fax: 585.232.3857 • E-mail: info@teltru.com • Web: www.teltru.com

► HOW TO ORDER:

To Build A Part Number: Select one code from each column to build your gauge.

DIAL	MODEL CODE	TUBE & SOCKET	CASE	CONN. SIZE	CONN. LOCATION	CONN. TYPE	RANGE & SCALE	OPTIONS
4-1/2"	45 10	S = 316SS M = Monel	R = Polypropylene T = Phenolic	2 = 1/2" 4 = 1/4"	L = Lower	1 = NPT 2 = BSPT 3 = BSP straight	See Range Chart	G = Glycerine Fill P = Plastic Lens R = Restrictor S = Silicone Fill Ø = Dampened Movement Oxygen Cleaning *

* Oxygen cleaning is sold separately. Order part number 10000006.

Example:

Specs: 4-1/2", Model 10, 316SS, 1/2" Lower, NPT, 0-30 psi, Glycerine Fill

Select:

45 10	S	R	2	L	1	C6A	G
-------	---	---	---	---	---	-----	---

Ordering Format: 4510SR2L1C6AG

► STANDARD RANGES:

CODE = RANGE (psi)	INTERVALS (Hg) (psi)	DIVISIONS (Hg) (psi)	CODE = RANGE (psi)	INTERVALS (psi)	DIVISIONS (psi)	Code = RANGE (psi)	INTERVALS (psi)	DIVISIONS (psi)
V1K = VAC 30" Hg-0	5"	.2"	B7A = 0-15	1	.1	F8A = 0-1000	100	10
Z1A = 30-0-15	5" 3	.5" .2	C6A = 0-30	5	.2	H2A = 0-1500	300	10
Z2A = 30-0-30	10" 5	1" .5	D6A = 0-60	10	.5	H5A = 0-2000	200	20
Z3A = 30-0-60	10" 10	1" 1	D9A = 0-100	10	1	H9A = 0-3000	500	20
Z4A = 30-0-100	30" 10	2" 1	E4A = 0-160	20	2	J8A = 0-5000	500	50
Z6A = 30-0-200	30" 20	5" 2	E5A = 0-200	20	2	K4A = 0-10,000	1000	100
			E8A = 0-300	50	2	K7A = 0-15,000	3000	100
			F2A = 0-400	50	5			
			F4A = 0-600	100	5			
			F7A = 0-800	100	10			

ALTITUDE RANGES

CODE = RANGE (ft./H ₂ O/psi)	FIGURE INTERVALS (ft.)	INTERVALS (psi)	DIVISIONS (ft.)	DIVISIONS (psi)
C8T = 0-35/0-15	5	3	.5	.25
G1T = 0-70/0-30	5	5	.5	.25
E2T = 0-140/0-60	10	5	1	1
N8T = 0-230/0-100	20	10	5	1
N9T = 0-370/0-160	40	20	5	2
N7T = 0-460/0-200	40	20	10	2
N6T = 0-690/0-300	50	30	10	5

RECEIVER RANGES

CODE = RANGE	FIGURE INTERVALS	DIVISIONS
V6V = 3-15 psi (0-100%)	10	1

AMMONIA RANGES

CODE = RANGE (psi)	INTERVALS (Hg) (psi)	DIVISIONS (Hg) (psi)
U6Y = 30-0-150	30" 20	5" 2
Z7Y = 30-0-300	30" 20	5" 5

NOTE: ABOVE 15,000 PSI AVAILABLE ONLY WITH 1/2" BSP STRAIGHT CONNECTION (G¹/₂).
NOTE: OTHER RANGES AND SCALES AVAILABLE. CONSULT FACTORY.

MODEL 30

1% STAINLESS STEEL PRESSURE GAUGES - DRY OR LIQUID FILLED

Designed for heavy duty service in process and industrial applications such as chemical, petrochemical, power, food processing and biotechnology.



SPECIFICATIONS:

Dial Size:	2-1/2", 4" or 6"
Accuracy:	±1% FS - ANSI Grade 1A
Case:	304SS
Bezel:	304SS Bayonet Lock Type
Socket:	316SS or Monel
Bourdon Tube:	316SS or Monel
Movement:	316SS or Monel with Overload/ Underload Stops
Lens:	Laminated Safety Glass
Pointer:	2-1/2": Non-Adjustable 4": Friction Adjustable 6": Micrometer Adjustable
Dial:	Heavy Gage Aluminum
Connection:	2-1/2": 1/4" NPT Lower or Center Back 4": 1/4" NPT & 1/2" NPT Lower or Lower Back 6": 1/2" NPT Lower or Lower Back
Range:	See Range Chart
Scales:	psi (metric available)
Protection Standard:	IP65 in accordance with NF EN 60529

► AVAILABLE OPTIONS:

- U-Clamp (2-1/2" - 4")
- Front Flange (back mount only)
- Back Flange
- Fill (Glycerine Standard)
- Other Fluids Available
- Drag Pointer (4" & dry only)
- Oxygen Cleaning (dry only)

MODEL CODES:

Model 30S	316SS Tube and Socket
Model 30M	Monel Tube and Socket

Estimated Shipping Weights		
DIAL SIZE	DRY	FILLED
2-1/2"	6 oz.	9 oz.
4"	1 lb. 3 oz.	2 lbs.
6"	2 lbs. 1 oz.	3 lbs. 6 oz.

► AVAILABLE CASE STYLES AND DIMENSIONS:

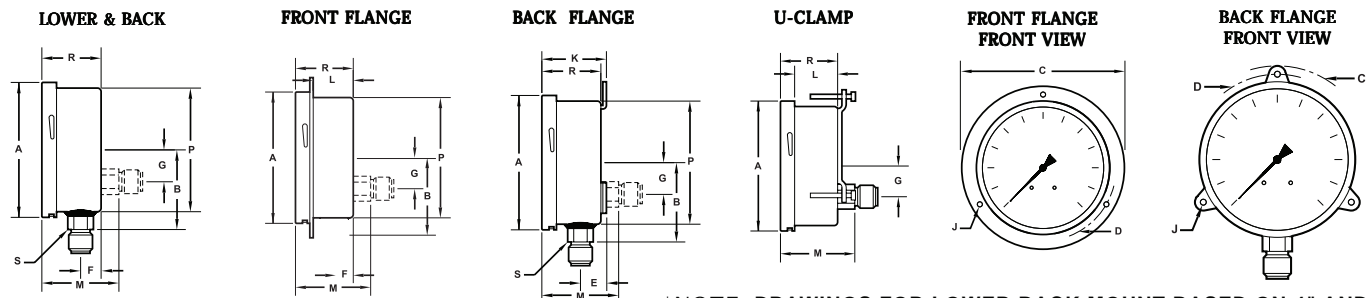

*NOTE: DRAWINGS FOR LOWER BACK MOUNT BASED ON 4" AND 6"

DIAL	A	B	C	D	E	F	G	J	K	L	M	P	R	S
2-1/2"	2.66" (67,6mm)		3.19" (81mm)	2.95" (75mm)		.43" (11mm)		.14" (3,6mm)		.69" (17,5mm)	1.46" (37mm)	2.48" (63mm)	1.12" (28,5mm)	.55" (14mm)
4"	4.18" (106,2mm)	2.48" (63mm)	5.12" (130mm)	4.65" (118mm)	1.00" (25,5mm)	.91" (23mm)	1.24" (31,5mm)	.22" (5,5mm)	2.22" (56,5mm)	1.55" (39,3mm)	2.70" (68,5mm)	3.86" (98mm)	2.15" (54,5mm)	.87" (22mm)
6"	5.91" (150,2mm)	3.35" (85mm)	7.09" (180mm)	6.61" (168mm)	1.00" (25,5mm)	.91" (23mm)	1.24" (31,5mm)	.22" (5,5mm)	2.22" (56,5mm)	1.55" (39,3mm)	2.70" (68,5mm)	5.59" (142mm)	2.15" (54,5mm)	.87" (22mm)



Tel-Tru Manufacturing Company
 408 St. Paul Street, Rochester, New York 14605 USA
 Phone: 585.232.1440 • 800.232.5335 • Fax: 585.232.3857 • E-mail: info@teltru.com • Web: www.teltru.com

► HOW TO ORDER:

To Build A Part Number: Select one code from each column to build your gauge.

DIAL	MODEL CODE	TUBE & SOCKET	CASE	CONN. SIZE	CONN. LOCATION	CONN. TYPE	RANGE & SCALE	OPTIONS
2-1/2"	25 30	S = 316SS M = Monel	S = Stainless Steel	4 = 1/4"	L = Lower C = Center Back	1 = NPT 2 = BSPT 3 = BSP straight	See Range Chart (Up to range of 10,000 psi)	E = Back Flange F = Front Flange* G = Glycerine Fill R = Restrictor S = Silicone Fill U-Clamp ** (sold separately) Oxygen Cleaning ***
4"	40 30	S = 316SS M = Monel	S = Stainless Steel	2 = 1/2" 4 = 1/4"	L = Lower B = Lower Back	1 = NPT 2 = BSPT 3 = BSP straight	See Range Chart	D = Drag Pointer E = Back Flange F = Front Flange* G = Glycerine Fill R = Restrictor S = Silicone Fill V = U-Clamp Oxygen Cleaning ***
6"	60 30	S = 316SS M = Monel	S = Stainless Steel	2 = 1/2" 4 = 1/4"	L = Lower B = Lower Back	1 = NPT 2 = BSPT 3 = BSP straight	See Range Chart	E = Back Flange F = Front Flange* G = Glycerine Fill S = Silicone Fill R = Restrictor Oxygen Cleaning ***

* Front Flange available on Back Mount only
 ** U-clamp on 2-1/2" dial is sold separately. Order part number 95-1701
 *** Oxygen cleaning is sold separately. Order part number 10000006.

Example:

Specs: 2-1/2", Model 30, 316SS, 1/4" Lower, NPT, 0-1500 psi, Glycerine

Select:	25 30	S	S	4	L	1	H2A	G
----------------	-------	---	---	---	---	---	-----	---

Ordering Format: 2530SS4L1H2AG

► STANDARD RANGES:

CODE = RANGE (psi)	INTERVALS (Hg) (psi)	DIVISIONS (Hg) (psi)
V1K = 30" Hg	5"	.2"
Z1A = 30-0-15	5" 5	.5" .2
Z2A = 30-0-30	5" 5	1" .5
Z3A = 30-0-60	10" 10	1" 1
Z4A = 30-0-100	30" 10	5" 2
Z5A = 30-0-160	30" 20	5" 2
Z6A = 30-0-200	30" 20	5" 2

CODE = RANGE (psi)	INTERVALS (psi)	DIVISIONS (psi)
B7A = 0-15	3	.1
C6A = 0-30	5	.2
D6A = 0-60	10	.5
D9A = 0-100	10	1
E4A = 0-160	20	2
E5A = 0-200	20	2
E8A = 0-300	50	2
F2A = 0-400	50	5
F4A = 0-600	100	5
F7A = 0-800	100	10

CODE = RANGE (psi)	INTERVALS (psi)	DIVISIONS (psi)
F8A = 0-1000	100	10
H2A = 0-1500	300	10
H5A = 0-2000	200	20
H9A = 0-3000	500	20
J4A = 0-4000	500	50
J8A = 0-5000	500	50
K4A = 0-10,000	1000	100
K7A = 0-15,000	3000	100

NOTE: INTERVALS AND DIVISION BASED ON 4" DIAL SIZE. CONTACT FACTORY TO REQUEST INFORMATION ON OTHER DIAL SIZES.
NOTE: ABOVE 15,000 PSI AVAILABLE ONLY WITH 1/2" BSP STRAIGHT CONNECTION (G^{1/2}).
NOTE: OTHER RANGES AND SCALES AVAILABLE. CONSULT FACTORY.

MODEL 31

1% SOLID FRONT STAINLESS STEEL PRESSURE GAUGES DRY OR LIQUID FILLED

Solid front, blowout back, field fillable model, designed for the rugged applications of the process and power industries.



SPECIFICATIONS:

Dial Size:	4" (100mm)
Accuracy:	±1% FS - ANSI Grade 1A
Case:	304SS
Bezel:	304SS Bayonet Lock Type
Socket:	316SS or Monel
Bourdon Tube:	316SS or Monel
Movement:	316SS with Overload/Underload Stops
Lens:	Laminated Safety Glass
Pointer:	Friction Adjustable
Dial:	Heavy Gage Aluminum
Connection:	4" - 1/4" NPT or 1/2" NPT Lower (Fully Welded)
Range:	See Range Chart
Scales:	psi (metric available)
Blow Out Back:	Standard
Protection Standard:	IP65 in accordance with NF EN 60529

► AVAILABLE OPTIONS:

- Fill (Glycerine Standard) • Oxygen Cleaning (dry only)
- Other Fluids Available
- Back Flange
- Restrictor

MODEL CODES:

Model 31S	316SS Tube and Socket
Model 31M	Monel Tube and Socket

Estimated Shipping Weights		
DIAL SIZE	DRY	FILLED
4"	1 lb. 8 oz.	2 lbs. 4 oz.

► AVAILABLE CASE STYLES AND DIMENSIONS:

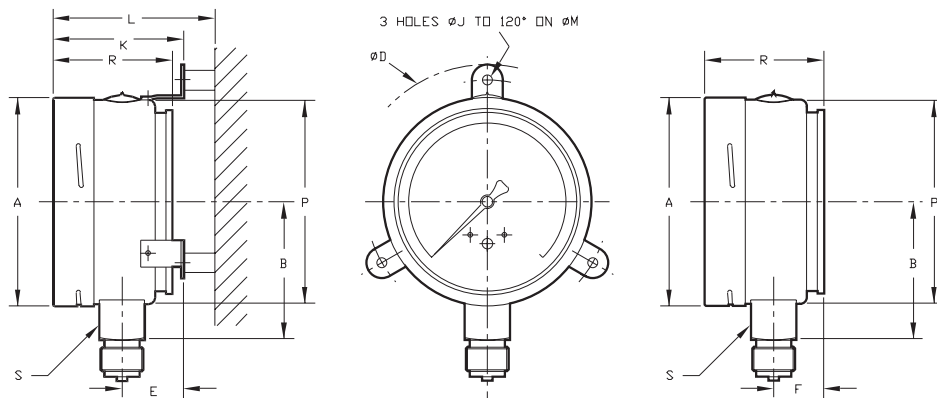

DIAL	A	B	D	E	F	J	K	L	M	P	R	S
4"	3.98" (101mm)	2.64" (67mm)	5.24" (133mm)	1.18" (30mm)	.96" (24.5mm)	.19" (4.8mm)	2.50" (63mm)	3.09" (78.5mm)	4.65" (118mm)	3.9" (99mm)	2.28" (58mm)	.87" (22mm)



Tel-Tru Manufacturing Company
 408 St. Paul Street, Rochester, New York 14605 USA
 Phone: 585.232.1440 • 800.232.5335 • Fax: 585.232.3857 • E-mail: info@teltru.com • Web: www.teltru.com

► HOW TO ORDER:

To Build A Part Number: Select one code from each column to build your gauge.

DIAL	MODEL CODE	TUBE & SOCKET	CASE	CONN. SIZE	CONN. LOCATION	CONN. TYPE	RANGE & SCALE	OPTIONS
4"	4031	S = 316SS M = Monel	S = Stainless Steel	2 = 1/2" 4 = 1/4"	L = Lower	1 = NPT 2 = BSPT 3 = BSP straight	See Range Chart	E = Back Flange G = Glycerine Fill R = Restrictor S = Silicone Fill Oxygen Cleaning *

* Oxygen cleaning is sold separately. Order part number 10000006.

Example:

Specs: 4", Model 31, 316SS, 1/4" Lower, NPT, 0-1500 psi, Glycerine

Select:

40 31	S	S	4	L	1	H2A	G
-------	---	---	---	---	---	-----	---

Ordering Format: 4031SS4L1H2AG

► STANDARD RANGES:

CODE = RANGE (psi)	INTERVALS (Hg) (psi)	DIVISIONS (Hg) (psi)
V1K = 30" Hg	5"	.5"
Z1A = 30-0-15	5" 3	1" .5
Z2A = 30-0-30	10" 5	1" .5
Z3A = 30-0-60	10" 10	2" 1
Z4A = 30-0-100	30" 10	5" 2
Z5A = 30-0-160	30" 20	5" 2

CODE = RANGE (psi)	INTERVALS (psi)	DIVISIONS (psi)
B7A = 0-15	3	.2
C6A = 0-30	5	.5
D6A = 0-60	10	.5
D9A = 0-100	10	1
E4A = 0-160	20	2
E5A = 0-200	20	2
E8A = 0-300	50	2
F2A = 0-400	50	5
F4A = 0-600	100	5
F7A = 0-800	100	10

CODE = RANGE (psi)	INTERVALS (psi)	DIVISIONS (psi)
F8A = 0-1000	100	10
H2A = 0-1500	200	20
H5A = 0-2000	200	50
H9A = 0-3000	500	50
J4A = 0-4000	500	50
J8A = 0-5000	500	100
K4A = 0-10,000	1000	100
K7A = 0-15,000	3000	100

NOTE: ABOVE 15,000 PSI AVAILABLE ONLY WITH 1/2" BSP STRAIGHT CONNECTION (G'1/2).
 NOTE: OTHER RANGES AND SCALES AVAILABLE. CONSULT FACTORY.

MODEL 32

1.5% ALL STAINLESS STEEL PRESSURE GAUGES - DRY OR LIQUID FILLED

Corrosion resistant gauge for general service applications.



SPECIFICATIONS:

Dial Size:	2-1/2"
Accuracy:	1.5% FS - ANSI Grade A
Case:	304SS
Bezel:	304SS Crimped
Socket:	316SS
Bourdon Tube:	316SS
Movement:	316SS
Lens:	Polycarbonate
Pointer:	Aluminum, Non-Adjustable
Dial:	Heavy Gage Aluminum
Connection:	1/4" NPT Lower or Center Back
Range:	See Range Chart
Scales:	psi & bar (kPa = bar x 100)
Protection Standard:	IP65 in accordance with NF EN 60529

Estimated Shipping Weights

DIAL SIZE	DRY	FILLED
2-1/2"	6 oz.	9 oz.

▶ AVAILABLE OPTIONS:

- Fill (Glycerine Standard)
- Other Fluids Available
- Oxygen Cleaning (dry)
- Restrictor

▶ AVAILABLE CASE STYLES AND DIMENSIONS:

LOWER & BACK

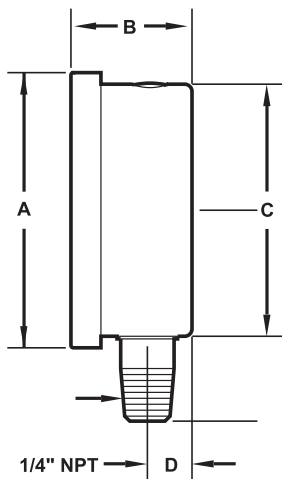

DIAL	A	B	C	D
2-1/2"	2.68" (68mm)	1.18" (30mm)	2.47" (63mm)	.41" (10mm)



Tel-Tru Manufacturing Company
 408 St. Paul Street, Rochester, New York 14605 USA
 Phone: 585.232.1440 • 800.232.5335 • Fax: 585.232.3857 • E-mail: info@teltru.com • Web: www.teltru.com

► HOW TO ORDER:

To Build A Part Number: Select one code from each column to build your gauge.

DIAL	MODEL CODE	TUBE & SOCKET	CASE	CONN. SIZE	CONN. LOCATION	CONN. TYPE	RANGE & SCALE	OPTIONS
2-1/2"	25 32	S = 316SS	S = Stainless Steel	4 = 1/4"	L = Lower C = Center Back*	1 = NPT	See Range Chart	G = Glycerine Fill R = Restrictor S = Silicone Fill Oxygen Cleaning **

* Center Back mount available on special order.
 ** Oxygen cleaning is sold separately. Order part number 10000006.

Example:

Specs: 2-1/2", Model 32S, 316SS, 1/4" NPT Lower, 0-160 psi/bar, Glycerine Fill

Select:

25 32	S	S	4	L	1	E4F	G
-------	---	---	---	---	---	-----	---

Ordering Format: 2532SS4L1E4FG

► STANDARD RANGES:

Note: Dual Scale, psi/bar (KPA = bar x 100)

CODE = RANGE (psi)	INTERVALS (Hg) (psi)	DIVISIONS (Hg) (psi)
V1Z = 30" Hg	5"	.5"
Z1Z = 30-0-15	5" 3	1" .5
Z2Z = 30-0-30	10" 5	1" .5
Z3Z = 30-0-60	10" 10	2" 1

CODE = RANGE (psi)	INTERVALS (psi)	DIVISIONS (psi)
B7F = 0-15	2	.2
C6F = 0-30	5	.5
D6F = 0-60	10	1
D9F = 0-100	10	2
E4F = 0-160	20	2
E5F = 0-200	20	2
E8F = 0-300	50	5
F2F = 0-400	50	5
F4F = 0-600	100	20

CODE = RANGE (psi)	INTERVALS (psi)	DIVISIONS (psi)
F8F = 0-1000	100	10
H2F = 0-1500	200	20
H5F = 0-2000	200	50
H9F = 0-3000	500	50
J8F = 0-5000	500	100
K4F = 0-10,000	1000	100

MODEL 33

INDUSTRIAL/HYDRAULIC PRESSURE GAUGES-DRY OR LIQUID FILLED

Typically used in OEM applications.



SPECIFICATIONS:

Dial Size:	1-1/2", 2", 2-1/2" or 4"
Accuracy:	±3-2-3% ANSI Grade B ±2-1-2% ANSI Grade A (4" SS only)
Case:	304SS
Bezel:	304SS Crimped
Socket:	Brass or 316SS
Bourdon Tube:	Brass or 316SS
Movement:	Brass or 316SS
Lens:	Polycarbonate
Pointer:	Aluminum
Dial:	Heavy Gage Aluminum
Connection:	See <i>How To Order Chart</i>
Restrictor:	Brass only
Range:	See <i>Range Chart</i>
Scales:	See <i>Range Chart</i>

▶ AVAILABLE OPTIONS:

- Fill
- Front Flange (sold separately)
- U-Clamp
- Restrictor (SS)

Note: U-Clamp and Front Flange NOT available on 4"

Estimated Shipping Weights		
DIAL SIZE	DRY	FILLED
1-1/2"	4 oz.	5 oz.
2"	4 oz.	6 oz.
2-1/2"	5 oz.	9 oz.
4"	1 lb. 3 oz.	2 lbs.

▶ AVAILABLE CASE STYLES AND DIMENSIONS:

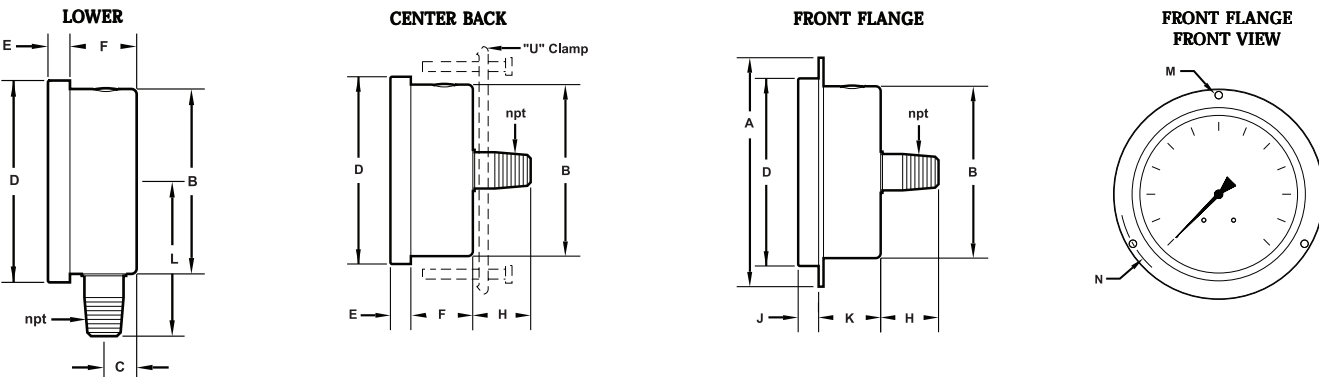

DIAL	A	B	C	D	E	F	H	J	K	L	M	N
1-1/2"	2.42" (62mm)	1.61" (41mm)	.34" (9mm)	1.77" (45mm)	.21" (5mm)	.79" (20mm)	.73" (19mm)	.21" (5mm)	.80" (20mm)	1.50" (38mm)	.14" (4mm)	1.97" (50mm)
2"	2.87" (73mm)	2.04" (52mm)	.40" (10mm)	2.21" (56mm)	.20" (5mm)	.90" (23mm)	.95" (24mm)	.19" (5mm)	.91" (23mm)	1.93" (49mm)	.14" (4mm)	2.44" (62mm)
2-1/2"	3.43" (87mm)	2.47" (63mm)	.41" (10mm)	2.68" (68mm)	.24" (6mm)	.94" (24mm)	.87" (22mm)	.18" (5mm)	1.00" (25mm)	2.20" (56mm)	.14" (4mm)	2.99" (76mm)
4"	5.12" (130mm)	3.88" (99mm)	.47" (12mm)	4.29" (109mm)	.30" (8mm)	1.12" (28mm)	1.38" (35mm)	.37" (9mm)	1.05" (27mm)	3.14" (80mm)	.17" (4mm)	4.57" (116mm)



Tel-Tru Manufacturing Company
 408 St. Paul Street, Rochester, New York 14605 USA
 Phone: 585.232.1440 • 800.232.5335 • Fax: 585.232.3857 • E-mail: info@teltru.com • Web: www.teltru.com

► HOW TO ORDER:

To Build A Part Number: Select one code from each column to build your gauge.

DIAL	MODEL CODE	TUBE & SOCKET	CASE	CONN. SIZE	CONN. LOCATION	CONN. TYPE	RANGE & SCALE	OPTIONS
1-1/2"	15 33	B = Brass S = SS	S = Stainless Steel	1 = 1/8"	L = Lower C = Center Back	1 = NPT	See Range Chart	Front Flange* T = Dry (No Fill) G = Glycerine Fill S = Silicone fill
2"	20 33	B = Brass S = SS	S = Stainless Steel	4 = 1/4"	L = Lower C = Center Back	1 = NPT	See Range Chart	Front Flange* T = Dry (No Fill) G = Glycerine Fill S = Silicone fill
2-1/2"	25 33	B = Brass S = SS	S = Stainless Steel	4 = 1/4"	L = Lower C = Center Back	1 = NPT	See Range Chart	Front Flange* U-Clamp** (sold separately) T = Dry (No Fill) G = Glycerine Fill S = Silicone fill
4"	40 33	B = Brass S = SS	S = Stainless Steel S = Stainless Steel	4 = 1/4" 2 = 1/2"	L = Lower	1 = NPT	See Range Chart	T = Dry (No Fill) G = Glycerine Fill S = Silicone fill

* Front Flange available on Back Mount only. When ordering specify part number 1-1/2" = 95-1726, 2" = 95-1727, or 2-1/2" = 95-1728

** U-clamp on 2-1/2" dial is sold separately. Order part number 95-1701

Example:

Specs: 2-1/2", Model 33B, Brass, 1/4"Center Back, NPT, 0-60 psi/bar, Dry (no fill) and with Front Flange

Select:

25 33	B	S	4	C	1	D6F	T
-------	---	---	---	---	---	-----	---

Ordering Format: 2533BS4C1D6FT and 95-1728

► 33B STANDARD RANGES:

Note--Dual Scale: psi/bar/kpa

CODE = RANGE (psi)	INTERVALS (Hg) (psi)	DIVISIONS (Hg) (psi)
V1Z = 30" Hg	5"	.5"
Z2Z = 30-0-30	10" 5	1" .5
Z3Z = 30-0-60	10" 10	2" 1
Z4Z = 30-0-100	30" 10	2" 2
Z5Z = 30-0-160	30" 20	10" 5

CODE = RANGE (psi)	INTERVALS (psi)	DIVISIONS (psi)
B7F = 0-15	2	.2
C6F = 0-30	3	.5
D6F = 0-60	5	1
D9F = 0-100	10	1
E4F = 0-160	20	2
E5F = 0-200	20	2
E8F = 0-300	30	5
F2F = 0-400	50	5
F4F = 0-600	50	10

CODE = RANGE (psi)	INTERVALS (psi)	DIVISIONS (psi)
F8F = 0-1000	100	10
H2F = 0-1500	200	20
H5F = 0-2000	200	20
H9F = 0-3000	300	100
J8F = 0-5000	500	100

► 33S STANDARD RANGES:

Note--Single Scale: psi

CODE = RANGE (psi)	INTERVALS (Hg) (psi)	DIVISIONS (Hg) (psi)
V1A = 30" Hg	5"	.5"
Z2A = 30-0-30	10" 5	1" .5
Z3A = 30-0-60	10" 10	2" 1
Z4A = 30-0-100	30" 10	2" 2
Z5A = 30-0-160	30" 20	10" 5
Z6A = 30-0-200	30" 20	10" 5
Z7A = 30-0-300	30" 30	10" 5

CODE = RANGE (psi)	INTERVALS (psi)	DIVISIONS (psi)
B7A = 0-15	2	.2
C6A = 0-30	5	.5
D6A = 0-60	10	1
D9A = 0-100	10	2
E4A = 0-160	20	2
E5A = 0-200	20	2
E8A = 0-300	50	5
F2A = 0-400	50	5
F4A = 0-600	100	10

CODE = RANGE (psi)	INTERVALS (psi)	DIVISIONS (psi)
F8A = 0-1000	100	20
H2A = 0-1500	300	20
H5A = 0-2000	200	20
H9A = 0-3000	500	50
J8A = 0-5000	1000	100
K1A = 0-6000	1000	100
K2A = 0-7500	1500	100
K4A = 0-10,000	1000	200

IMPORTANT NOTES:

- Intervals and division based on 4" dial size--SPECS MAY VARY.
- Other ranges available, minimum quantities required.

MODEL 37

1.5% LOW PRESSURE GAUGES

Designed for use where pressure of less than 10 psi is to be measured.



SPECIFICATIONS:

Dial Size:	4"
Accuracy:	±1.5% FS - ANSI Grade A
Case:	304SS
Bezel:	304SS Bayonet Lock Type
Socket:	316SS
Capsule:	316SS
Movement:	Brass
Lens:	Laminated Safety Glass
Pointer:	Aluminum
Dial:	Heavy Gage Aluminum
Adjustment::	Adjustable Set Screw
Connection:	1/4" or 1/2" NPT Lower & Lower Back (Fully Welded)
Range:	See Range Chart
Protection Standard:	IP65 in accordance with NF EN 60529

MODEL CODES:

Model 37S 316SS Capsule and Socket, 304SS Case

▶ AVAILABLE OPTIONS:

- Front Flange (back mount only)
- Back Flange
- U-Clamp

Estimated Shipping Weight	
DIAL SIZE	DRY
4"	1 lb. 10 oz.

▶ AVAILABLE CASE STYLES AND DIMENSIONS:

LOWER & BACK

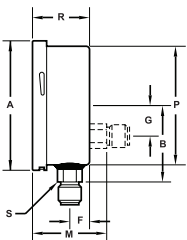

FRONT FLANGE

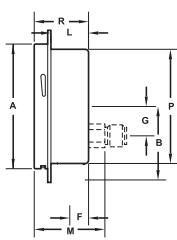

BACK FLANGE

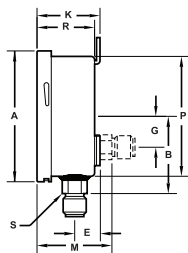

U-CLAMP

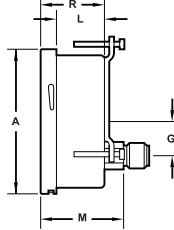

FRONT FLANGE
FRONT VIEW

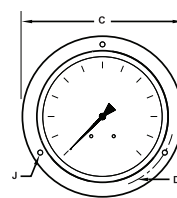

BACK FLANGE
FRONT VIEW

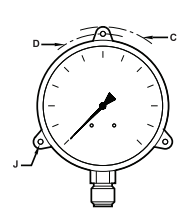

DIAL	A	B	C	D	E	F	G	J	K	L	M	P	R	S
4"	4.18" (106,2mm)	2.68" (68mm)	5.12" (130mm)	4.65" (118mm)	1.00" (25,4mm)	0.91" (23mm)	1.24" (31,5mm)	0.22" (5,5mm)	2.22" (56,4mm)	1.55" (39,3mm)	2.81" (71,5mm)	3.86" (98mm)	2.14" (54,5mm)	.87" (22mm)



Tel-Tru Manufacturing Company
 408 St. Paul Street, Rochester, New York 14605 USA
 Phone: 585.232.1440 • 800.232.5335 • Fax: 585.232.3857 • E-mail: info@teltru.com • Web: www.teltru.com

► HOW TO ORDER:

To Build A Part Number: Select one code from each column to build your gauge.

DIAL	MODEL CODE	TUBE & SOCKET	CASE	CONN. SIZE	CONN. LOCATION	CONN. TYPE	RANGE & SCALE	OPTIONS
4"	40 37	S = 316SS	S = Stainless Steel	2 = 1/2" 4 = 1/4"	L = Lower B = Lower Back	1 = NPT	See Range Chart	E = Back Flange F = Front Flange* V = U-Clamp*

*Available on Back Mount only

Example:

Specs: 4", Model 37, 316SS, 1/4" Lower, NPT, 0-30 IW, Back Flange

Select:

40 37	S	S	4	L	1	C6P	E
-------	---	---	---	---	---	-----	---

Ordering Format: 4037SS4L1C6PE

► STANDARD RANGES:

CODE = RANGE	INTERVALS	DIVISIONS
B1A = 0-5 psi	.5	.05
B4A = 0-10 psi	1	.1
V1P = -30-0 IWV	5	.2
B4P = 0-10 IW	1	.1
B7P = 0-15 IW	3	.1
C6P = 0-30 IW	5	.2
D6P = 0-60 IW	10	.5
D9P = 0-100 IW	10	1
E3P = 0-150 IW	30	1

NOTE: OTHER RANGES AVAILABLE.

MODEL 42

0.25% TEST GAUGES

Designed as a master reference for checking the accuracy of other pressure instruments.



SPECIFICATIONS:

Dial Size:	6"
Accuracy:	±0.25% FS - ANSI Grade 3A
Case:	304SS (Non-Fillable)
Bezel:	304SS Bayonet Lock Type
Socket:	316SS
Sensing Element:	316SS
Lens:	Laminated Safety Glass
Pointer:	Aluminum, Balanced, Light weight, Knife Edge
Dial:	Aluminum, Anti Parallax Mirror
Connection:	1/2" or 1/4" NPT, Lower or Lower Back
Range:	See Range Chart
Scales:	psi (metric available)
Safety Blowout Discs:	Standard
Protection Standard:	IP65 in accordance with NF EN 60529

Estimated Shipping Weight	
DIAL SIZE	DRY
6"	2 lbs. 6 oz.

▶ AVAILABLE OPTIONS:

- Front Flange (back mount only)
- Back Flange
- Calibration Certificate
- Oxygen Cleaning

▶ AVAILABLE CASE STYLES AND DIMENSIONS:

LOWER & BACK

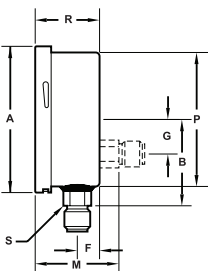

FRONT FLANGE

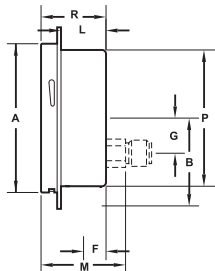

BACK FLANGE

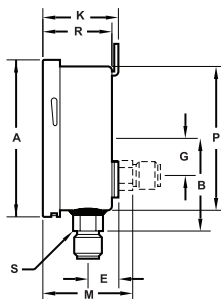

FRONT FLANGE FRONT VIEW

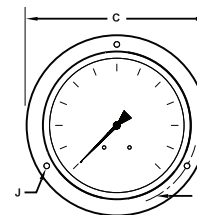

BACK FLANGE FRONT VIEW

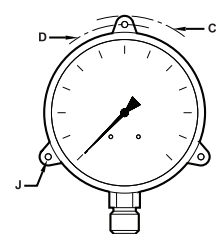

DIAL	A	B	C	D	E	F	G	J	K	L	M	P	R	S
6"	5.91" (150,2mm)	3.35" (85mm)	7.09" (180mm)	6.61" (168mm)	1.00" (25,4mm)	.91" (23mm)	1.24" (31,5mm)	0.22" (5,5mm)	2.22" (56,4mm)	1.55" (39,3mm)	2.70" (68,5mm)	5.59" (1,42mm)	2.15" (54,5mm)	0.87" (22mm)



Tel-Tru Manufacturing Company
 408 St. Paul Street, Rochester, New York 14605 USA
 Phone: 585.232.1440 • 800.232.5335 • Fax: 585.232.3857 • E-mail: info@teltru.com • Web: www.teltru.com

► TO ORDER:

To Build A Part Number: Select one code from each column to build your gauge.

DIAL	MODEL CODE	TUBE & SOCKET	CASE	CONN. SIZE	CONN. LOCATION	CONN. TYPE	RANGE & SCALE	OPTIONS
6"	60 42	S = 316SS	S = Stainless Steel	2 = 1/2" 4 = 1/4"	L = Lower B = Lower Back	1 = NPT 2 = BSPT 3 = BSP straight	See Range Chart	E = Back Flange F = Front Flange* R = Restrictor Oxygen Cleaning **

* Front Flange available on Back Mount only.

** Oxygen cleaning is sold separately. Order part number 10000006.

Example:

Specs: 6", Model 42S, 316SS, 1/2" Lower, NPT, 0-30 psi, Back Flange

Select:

60 42	S	S	2	L	1	C6A	E
-------	---	---	---	---	---	-----	---

Ordering Format: 6042SS2L1C6AE

► STANDARD RANGES:

CODE = RANGE (psi)	INTERVALS (Hg) (psi)	DIVISIONS (Hg) (psi)
V1K = 30" Hg	2"	.2"
Z2A = 30-0-30	10" 5	.1" .5

CODE = RANGE (psi)	INTERVALS (psi)	DIVISIONS (psi)
B7A = 0-15	3	.2
C6A = 0-30	2	.2
D6A = 0-60	5	.5
D9A = 0-100	10	.5
E4A = 0-160	10	1
E5A = 0-200	20	2
E8A = 0-300	20	2
F2A = 0-400	20	2
F4A = 0-600	50	5

CODE = RANGE (psi)	INTERVALS (psi)	DIVISIONS (psi)
F8A = 0-1000	100	5
H2A = 0-1500	100	10
H5A = 0-2000	100	10
H9A = 0-3000	200	20
J8A = 0-5000	500	50
K4A = 0-10,000	1000	50
K7A = 0-15,000	1000	100

NOTE: ABOVE 15,000 PSI AVAILABLE ONLY WITH 1/2" BSP STRAIGHT CONNECTION (G¹/₂).
NOTE: OTHER RANGES AND SCALES AVAILABLE. CONSULT FACTORY.

MODEL 50

METAL CASE UTILITY PRESSURE GAUGES

Designed for general commercial and industrial markets to measure air, water, oil, gas or any medium not corrosive to brass.



SPECIFICATIONS:

Dial Size:	1-1/2", 2", 2-1/2" or 3-1/2"
Accuracy:	±3-2-3% ANSI Grade B
Case:	Black Painted Metal (dry only)
Socket:	Brass
Bourdon Tube:	Phosphor Bronze
Movement:	Brass
Lens:	Acrylic
Pointer:	Aluminum
Dial:	Aluminum
Connection:	1-1/2": 1/8" NPT Lower or Center Back 2": 1/8" NPT or 1/4" NPT Lower or Center Back 2-1/2": 1/4" NPT Lower or Center Back 3-1/2": 1/4" NPT Lower
Range:	See Range Chart
Scales:	psi & bar (kPa = bar x 100)

➤ AVAILABLE OPTIONS:

- Oxygen Cleaning
- **Other configurations available upon request**

Estimated Shipping Weight	
DIAL SIZE	DRY
1-1/2"	3 oz.
2"	5 oz.
2-1/2"	5 oz.
3-1/2"	8 oz.

➤ AVAILABLE CASE STYLES AND DIMENSIONS:

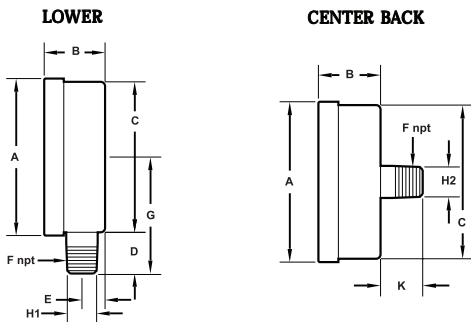

DIAL	NPT	A	B	C	D	E	G	H1	H2	K
1-1/2"	1/8"	1.69" (42,9mm)	1.06" (26,9mm)	1.65" (41,9mm)	0.82" (20,8mm)	0.35" (8,9mm)	1.65" (41,9mm)	0.55" (14mm)	0.47" (11,9mm)	0.67" (17mm)
2"	1/8"	2.13" (54,1mm)	1.10" (27,9mm)	2.05" (52,1mm)	0.82" (20,8mm)	0.35" (8,9mm)	1.85" (47mm)	0.55" (14mm)	0.55" (14mm)	0.90" (22,9mm)
2"	1/4"	2.13" (54,1mm)	1.10" (27,9mm)	2.05" (52,1mm)	0.94" (23,9mm)	0.35" (8,9mm)	1.97" (50mm)	0.55" (14mm)	0.55" (14mm)	0.90" (22,9mm)
2-1/2"	1/4"	2.52" (64mm)	1.10" (27,9mm)	2.48" (63mm)	0.92" (23,4mm)	0.35" (8,9mm)	2.16" (54,9mm)	0.55" (14mm)	0.55" (14mm)	0.90" (22,9mm)
3-1/2"	1/4"	3.54" (89,9mm)	1.18" (30mm)	3.44" (87,4mm)	0.96" (24,4mm)	0.43" (10,9mm)	2.68" (68,1mm)	0.55" (14mm)		



Tel-Tru Manufacturing Company
 408 St. Paul Street, Rochester, New York 14605 USA
 Phone: 585.232.1440 • 800.232.5335 • Fax: 585.232.3857 • E-mail: info@teltru.com • Web: www.teltru.com

► HOW TO ORDER:

To Build A Part Number: Select dial size & then select one code from each column to build your gauge.

DIAL	MODEL CODE	TUBE & SOCKET	CASE	CONN. SIZE	CONN. LOCATION	CONN. TYPE	RANGE & SCALE	OPTIONS
1-1/2"	15 50	B = Brass	C = Black Painted Steel	1 = 1/8"	L = Lower C = Center Back	1 = NPT	See Range Chart Up to 600 psi	Oxygen Cleaning *
2"	20 50	B = Brass	C = Black Painted Steel	1 = 1/8" 4 = 1/4"	L = Lower C = Center Back	1 = NPT	See Range Chart Up to 600 psi	Oxygen Cleaning *
2-1/2"	25 50	B = Brass	C = Black Painted Steel	4 = 1/4"	L = Lower C = Center Back	1 = NPT	See Range Chart	Oxygen Cleaning *
3-1/2"	35 50	B = Brass	C = Black Painted Steel	4 = 1/4"	L = Lower	1 = NPT	See Range Chart	Oxygen Cleaning *

* Oxygen cleaning is sold separately. Order part number 10000006.

Example:

Specs: 1-1/2", Model 50B, Brass, Black Painted Steel, 1/8" Lower, NPT, 0-600 psi/bar

Select:

15 50	B	C	1	L	1	F4F
-------	---	---	---	---	---	-----

Ordering Format: 1550BC1L1F4FL

► STANDARD RANGES:

Note: Dual Scale, psi/bar (KPA = bar x 100)

CODE = RANGE (psi)	INTERVALS (Hg) (psi)	DIVISIONS (Hg) (psi)
V1Z = 30" Hg	5"	.5"
Z2Z = 30-0-30	10" 10	1" 1
Z3Z = 30-0-60	10" 10	2" 1

CODE = RANGE (psi)	INTERVALS (psi)	DIVISIONS (psi)
B7F = 0-15	2	.2
C6F = 0-30	5	.5
D6F = 0-60	10	1
D9F = 0-100	20	2
E4F = 0-160	20	2
E5F = 0-200	40	5
E8F = 0-300	50	5
F2F = 0-400	50	5
F4F = 0-600	100	10

CODE = RANGE (psi)	INTERVALS (psi)	DIVISIONS (psi)
F8F = 0-1000	200	20



MODEL 51

PLASTIC CASE UTILITY PRESSURE GAUGES

General utility gauge designed for the pool, spa, and irrigation industries.



SPECIFICATIONS:

Dial Size:	1-1/2" or 2"
Accuracy:	±3-2-3% - ANSI Grade B
Case:	ABS Black Plastic (dry only)
Socket:	Brass
Bourdon Tube:	Phosphor Bronze
Movement:	Brass
Lens:	Acrylic
Pointer:	Aluminum
Dial:	Aluminum
Connection:	1-1/2": 1/8" NPT Center Back 2": 1/8" NPT or 1/4" NPT Lower or Center Back
Range:	See Range Chart
Scales:	psi

Estimated Shipping Weight	
DIAL SIZE	DRY
1-1/2"	3 oz.
2"	4 oz.

➤ AVAILABLE CASE STYLES AND DIMENSIONS:

DIAL	A	B	C	D	E	F	G	H	K
1-1/2"	1.76" (44,7mm)		1.76" (44,7mm)			1.06" (26,9mm)		0.47" (11,9mm)	0.62" (15,7mm)
2"	2.12" (53,8mm)	1.10" (27,9mm)	2.08" (52,8mm)	0.87" (22,1mm)	0.35" (8,9mm)	1.06" (26,9mm)	1.93" (49mm)	0.55" (14mm)	0.90" (22,9mm)

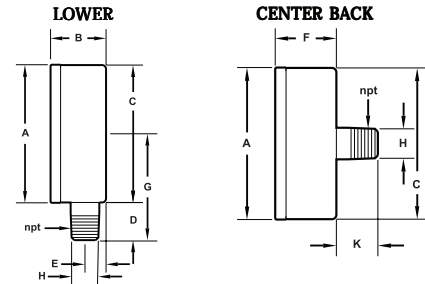

➤ HOW TO ORDER:

To Build A Part Number: Select one code from each column to build your gauge.

DIAL	MODEL CODE	TUBE & SOCKET	CASE	CONN. SIZE	CONN. LOCATION	CONN. TYPE	RANGE & SCALE
1-1/2"	15 51	B = Brass	P = ABS Black Plastic	1 = 1/8"	C = Center Back	1 = NPT	See Range Chart
2"	20 51	B = Brass	P = ABS Black Plastic	1 = 1/8" 4 = 1/4"	L = Lower C = Center Back	1 = NPT	See Range Chart

Example:

Specs: 1-1/2", Model 51B, Brass, Black Plastic, 1/8" Center Back, NPT, 0-30 psi

Select:	15 51	B	P	1	C	1	C6A
----------------	-------	---	---	---	---	---	-----

Ordering Format: 1551BP1C1C6A

➤ STANDARD RANGES*:

CODE = RANGE (psi)	INTERVALS (Hg) (psi)	DIVISIONS (Hg) (psi)
Z3A = 30-0-60	10" 10	2" 1
Z2A = 30-0-30	10" 10	2" 2
C6A = 0-30		5 2
D6A = 0-60		10 2
D9A = 0-100		20 2

*Other ranges available for special order, consult factory.

MODEL 52



MECHANICAL CONTRACTOR PRESSURE GAUGES

A utility gauge used with any liquid or gas not corrosive to bronze. Typically used for HVAC applications.



SPECIFICATIONS:

Dial Size:	4-1/2"
Accuracy:	±1% FS - ANSI Grade A
Case:	Stainless Steel (dry only)
Socket:	Brass
Bourdon Tube:	Phosphor Bronze
Movement:	Phosphor Bronze
Lens:	Acrylic
Pointer:	Aluminum, Adjustable
Dial:	Heavy Gage Aluminum
Connection:	1/4" NPT Lower Only
Restrictor:	Standard
Range:	See Range Chart
Scales:	psi

Estimated Shipping Weight	
DIAL SIZE	DRY
4-1/2"	13 oz.

► AVAILABLE CASE STYLES AND DIMENSIONS:

DIAL	A	B	C	D
4-1/2"	4.94" (125,4mm)	1.19" (30,2mm)	1.06" (26,9mm)	0.44" (11,2mm)

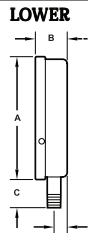

FRONT VIEW

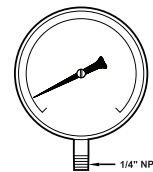

► HOW TO ORDER:

To Build A Part Number: Select one code from each column to build your gauge.

DIAL	MODEL CODE	TUBE & SOCKET	CASE	CONN. SIZE	CONN. LOCATION	CONN. TYPE	RANGE & SCALE
4-1/2"	45 52	B = Brass	S = Stainless Steel	4 = 1/4"	L = Lower	1 = NPT	See Range Chart

Example:

Specs: 4-1/2", Model 52B, Brass, Stainless Steel, 1/4" Lower NPT, 0-30 psi

Select:	45 52	B	S	4	L	1	C6A
----------------	-------	---	---	---	---	---	-----

Ordering Format: 4552BS4L1C6A

► STANDARD RANGES:

CODE = RANGE (psi)	INTERVALS (psi)	DIVISIONS (psi)
Z2A = 30-0-30	5	1
Z3A = 30-0-60	10	2
B7A = 0-15	1	.25
C6A = 0-30	5	.5
D6A = 0-60	10	1
D9A = 0-100	20	2
E4A = 0-160	20	2
E5A = 0-200	20	2
E8A = 0-300	50	5
F2A = 0-400	50	5
F4A = 0-600	100	10

MODEL 55

LOW PRESSURE DIAPHRAGM-ACTUATED UTILITY PRESSURE GAUGES

Designed for use with air, gas, oil, water or any medium not corrosive to brass or bronze and where pressure of less than 10 psi is to be measured.

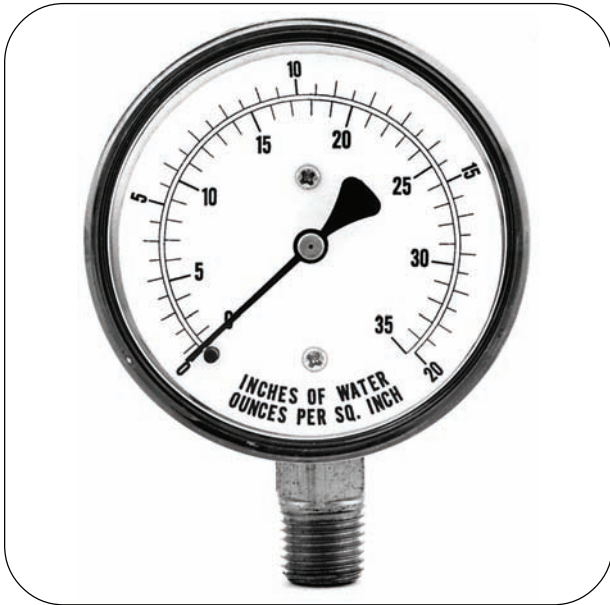

SPECIFICATIONS:

Dial Size:	2-1/2"
Accuracy:	±3-2-3% - ANSI Grade B
Case:	Black Painted Steel (dry only)
Socket:	Brass
Capsule:	Phosphor Bronze Diaphragm
Movement:	Brass
Lens:	Acrylic
Pointer:	Aluminum
Dial:	Aluminum
Connection:	1/4" NPT Lower or Center Back
Restrictor:	Standard
Zero Adjust:	Lower Mount Only
Range:	See Range Chart

Estimated Shipping Weight	
DIAL SIZE	DRY
2-1/2"	9 oz.

➤ AVAILABLE OPTIONS

- Oxygen Cleaning (dry)

➤ STANDARD RANGES:

CODE = RANGE	INTERVALS	DIVISIONS
B1A = 0-5 psi	1	.1
B4A = 0-10 psi	2	.2
B4P = 0-10 IW	2	.2
B7P = 0-15 IW	3	.2
C6P = 0-30 IW	5	.5
D6P = 0-60 IW	10	1
D9P = 0-100 IW	20	2
E3P = 0-150 IW	30	2
E5P = 0-200 IW	20	2
B7R = 0-15 IW/oz.	20	2
C8R = 0-35 IW/oz.	5	1
D6R = 0-60 IW/oz.	10	1
D9R = 0-100 IW/oz.	20	2

➤ AVAILABLE CASE STYLES AND DIMENSIONS:

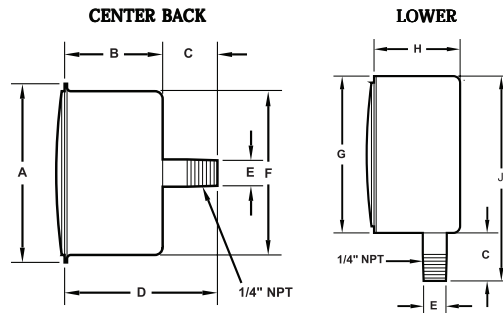

DIAL	A	B	C	D	E	F	G	H	J
2-1/2"	2.85" (72,4mm)	1.60" (40,6mm)	.85" (21,6mm)	2.45" (62,2mm)	.55" (14mm)	2.60" (66mm)	2.60" (66mm)	1.70" (43,2mm)	3.45" (87,6mm)

➤ HOW TO ORDER:

To Build A Part Number: Select one code from each column to build your gauge.

DIAL	MODEL CODE	TUBE & SOCKET	CASE	CONN. SIZE	CONN. LOCATION	CONN. TYPE	RANGE & SCALE	OPTIONS
2-1/2"	25 55	B = Brass	C = Black Painted Steel	4 = 1/4"	L = Lower C = Center Back	1 = NPT	See Range Chart	Oxygen Cleaning *

Example: **Specs:** 2-1/2", Model 55B, Brass, Black Painted Steel, 1/4" Lower, NPT, 0-5 psi

Select:	25 55	B	C	4	L	1	B1A
----------------	-------	---	---	---	---	---	-----

Ordering Format: 2555BC4L1B1AC

* Oxygen cleaning is sold separately. Order part number 10000006.



Tel-Tru Manufacturing Company
 408 St. Paul Street, Rochester, New York 14605 USA
 Phone: 585.232.1440 • 800.232.5335 • Fax: 585.232.3857 • E-mail: info@teltru.com • Web: www.teltru.com

Steam Gauge Siphons

Protect your instruments from high temperatures.

The pigtail siphon is used to protect the pressure gauge from temperatures above 150°F. It allows the hot medium to cool before entering the pressure gauge. In most instances an isolation valve is located below the the pressure gauge and siphon to insure that the medium in the siphon stays cool.



SIZE	TYPE	MATERIAL	PART NO.
1/4" NPT	Sch. 40 Welded	Steel A53	21AS
1/4" NPT	Sch. 40 Seamless	Steel A106B	21SS
1/4" NPT	Sch. 40	304SS	214S
1/4" NPT	Sch. 40	316SS	216S
1/4" NPT	Sch. 80 Seamless	Steel A106	21SX
1/4" NPT	Sch. 80	304SS	214X
1/4" NPT	Sch. 80	316SS	216X

SIZE	TYPE	MATERIAL	PART NO.
1/2" NPT	Sch. 40	Steel A106B	51SS
1/2" NPT	Sch. 40	304SS	514S
1/2" NPT	Sch. 40	316SS	516S
1/2" NPT	Sch. 80 Seamless	Steel A106B	51SX
1/2" NPT	Sch. 80	304SS	514X
1/2" NPT	Sch. 80	316SS	516X

Schedule 40 up to 1200 PSI at 600°F depending on size and material.
 Schedule 80 up to 3000 PSI at 650°F depending on size and material.

Brass Gauge Cocks

Used in conjunction with siphon as an isolation valve.



TYPE	SIZE	PART NO.
Tee Handle	1/4"	GC38
Lever Handle	1/4"	GC44
Lever Handle	1/2"	GC45A

*** NOT recommended for pressure OVER 100 psi**

Mini Needle Valve



Mini Needle Valve

Model TBV4

- Rated up to 600 PSI @ 300°F
- Brass 1/4" NPT Female x 1/4" NPT Female

Ray Snubbers™ POROUS METAL & PISTON TYPE SNUBBERS

A Simple, Cost Effective Solution To Protect Valuable Control Instruments...

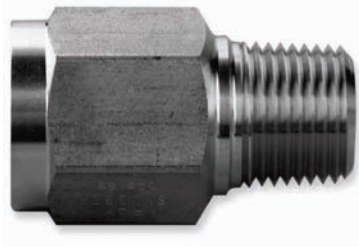

Ray Snubbers

Through its unique design, the **Ray Snubbers** rugged piston moving within its chamber kicks out the sediment and pipe scale that clog needle valves, filters, porous metal discs and other designs.

To accommodate variations in viscosities, every snubber is delivered with three different-sized easily changed pistons. And because the piston is the only moving part, maintenance is minimal. No parts to be regularly cleaned or replaced.

► PISTON CENTER JOINT SNUBBERS

Preferred for non repetitive installation. Center joint allows for easy piston changing.

Note: Other configurations are available--Consult Factory

MODEL 010

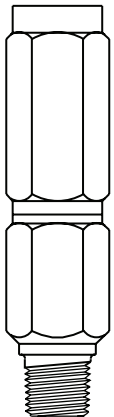

MODEL 010 - PISTON TYPE					
MODEL 010					
MODEL NO.	INLET/ OUTLET	BODY MTRL.	MAX. PSI	LN.	HEX
010B	1/4" NPT	Brass	3000	3.46	.750
010S	1/4" NPT	303SS	5000	3.46	.750
010SS	1/4" NPT	316SS	5000	3.46	.750

Available in British Taper Pipe Threads (add BSPT to part number)

MODEL 060

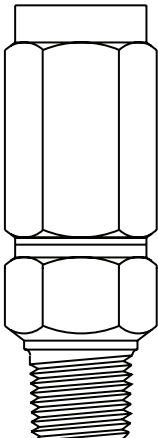

MODEL 060 - PISTON TYPE					
MODEL 060					
MODEL NO.	INLET/ OUTLET	BODY MTRL.	MAX. PSI	LN.	HEX
060B	1/2" NPT	Brass	5000	3.61	1.125
060S	1/2" NPT	303SS	10,000	3.61	1.125
060SS	1/2" NPT	316SS	10,000	3.61	1.125

Available in British Taper Pipe Threads (add BSPT to part number)

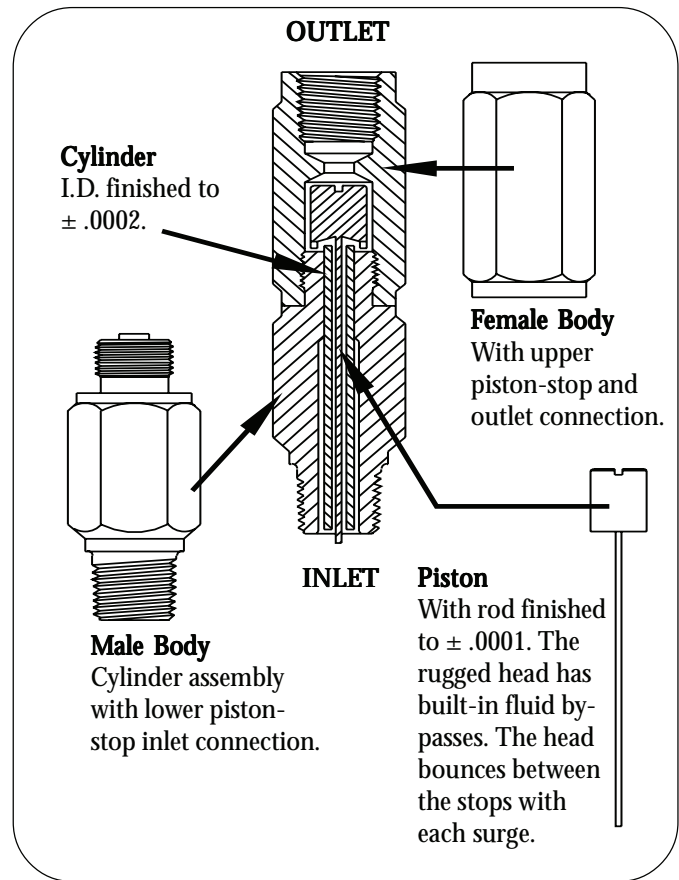



Tel-Tru Manufacturing Company
 408 St. Paul Street, Rochester, New York 14605 USA
 Phone: 585.232.1440 • 800.232.5335 • Fax: 585.232.3857 • E-mail: info@teltru.com • Web: www.teltru.com

► PISTON SOLID BODY SNUBBERS

Ideal for OEM market. Due to precision, pistons are interchangeable from unit to unit.

Note: Other configurations are available--Consult Factory

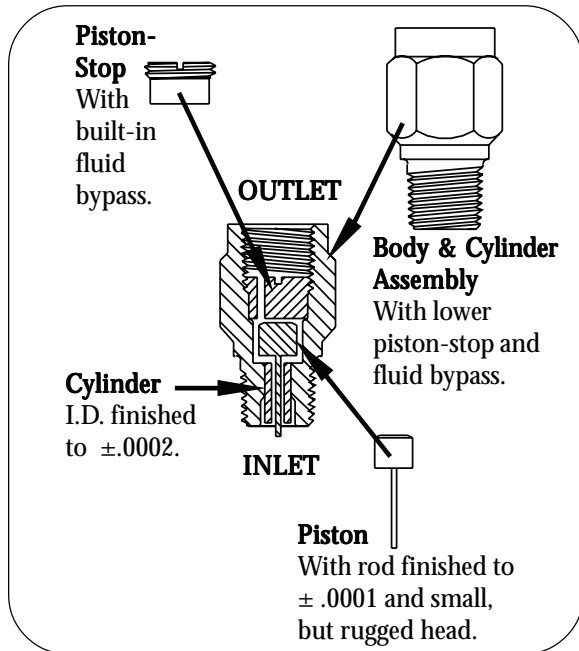

MODEL 047

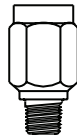

MODEL 047 - PISTON TYPE					
MODEL NO.	INLET/OUTLET	BODY MTRL.	MAX. PSI	LN.	HEX
047B	1/8" NPT	Brass	3000	1.5	.688
047S	1/8" NPT	303SS	5000	1.5	.688
047SS	1/8" NPT	316SS	5000	1.5	.688

MODEL 022

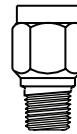

MODEL 022 - PISTON TYPE					
MODEL NO.	INLET/OUTLET	BODY MTRL.	MAX. PSI	LN.	HEX
022B	1/4" NPT	Brass	5000	1.5	.75
022M	1/4" NPT	Monel	5000	1.5	.75
022S	1/4" NPT	303SS	15,000	1.5	.75
022SS	1/4" NPT	316SS	15,000	1.5	.75

MODEL 023

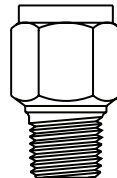

MODEL 023 - PISTON TYPE					
MODEL NO.	INLET/OUTLET	BODY MTRL.	MAX. PSI	LN.	HEX
023B	1/2" NPT	Brass	5000	2	1.125
023M	1/2" NPT	Monel	5000	2	1.125
023S	1/2" NPT	303SS	15,000	2	1.125
023SS	1/2" NPT	316SS	15,000	2	1.125

► RAY™ POROUS METAL PRESSURE SNUBBERS

Stop shocks and pulsations that damage pressure instruments. Cut maintenance, calibration and repair costs. RAY™ POROUS METAL PRESSURE SNUBBERS assure accuracy of instruments and readings. Prevents false operation of control equipment and increases the life of your valuable instruments.

Note: Other configurations are available--Consult Factory

POROUS METAL TYPE				
BODY TYPE.	MTRL.	MAX. PSI	LIGHT OIL & WATER "E" Porosity	AIR, STEAM & GAS "G" Porosity
1/4" NPT Length: 1.5" Weight: 2 oz.	Brass	5000	722BE	722BG
	303SS	15,000	722SE	722SG
1/2" NPT Length: 2.2" Weight: 8 oz.	Brass	5000	723BE	723BG
	303SS	15,000	723SE	723SG

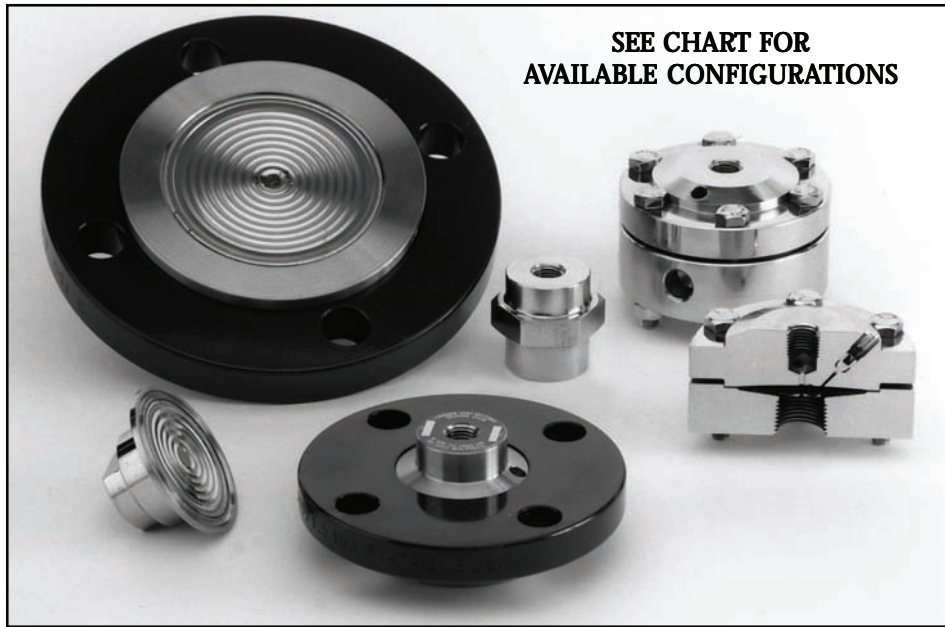

SEE CHART FOR
AVAILABLE CONFIGURATIONS

OTHER CONNECTION TYPES AND MATERIALS AVAILABLE UPON REQUEST

► MODEL W - WELDED DIAPHRAGM SEALS

Protective device used to isolate the pressure instrument from the process fluid being monitored.

- Diaphragm welded to upper housing to provide high integrity seal.
- Bolts can be removed and seal separated for cleaning, liquid filling, calibration, welding etc. without the loss of fill fluid.
- Available with flushing connection.
- Maximum pressure rating is 2500 PSIG on threaded type. Stainless steel bolts reduce the max. working pressure by 50%.

► MODEL M - MINI DIAPHRAGM SEALS

Economical Isolator designed to protect smaller gauges from heat corrosion and clogging.

- All welded construction, no gasketing or bolts.
- For use with most 3-1/2" and smaller gauges (100 PSIG minimum).

► MODEL S - SANITARY DIAPHRAGM SEALS

Designed for food, dairy and pharmaceutical industries to ensure that surfaces exposed to process are virtually crack and crevice free.

- Diaphragm is welded to the seal housing to provide sanitary type construction.
- Manufactured to meet design, material and fabrication requirements of 3-A Sanitary Standard.
- Seal may be removed from the system without loss of fluid.
- Fits most popular sanitary piping systems including Tri-Clover Tri-Clamp and others.

► TYPICAL DIMENSIONS:

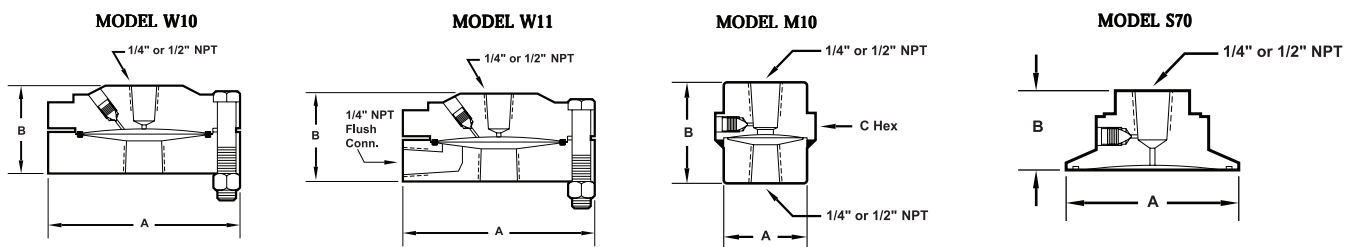

► TYPICAL CONFIGURATIONS:

MODEL	A	B	C
W10X/W11X	3.50" (89mm)	2.4" (46mm)	
M10B	1.38" (35mm)	1.50" (38mm)	1.73" (44mm)
S70X7	1.98" (51mm)	1.42" (28mm)	

► HOW TO ORDER: Note: Filled Diaphragm Seals Are Ordered As Sets With Pressure Gauges

To Build A Part Number: Select one code from each column to build your diaphragm seal.

MODEL	TYPE	MAX. PRESS. RATING*	PROCESS CONN.	CONN. TYPE	WETTED MATERIALS LOWER HSE./DIAPHRAGM	GASKET	UPPER HSE. MAT.	INST. CONN.	BOLTS
W Welded Threaded Offline	10 = Threaded off line	X = Depends on final configuration	1= 1/4"	1 = NPT	SS = 316LSS/316LSS EE = Hastelloy C/Hastelloy C JT = Monel/Tantalum ET = Hastelloy C/Tantalum	G =Grafoil K =C-4401 T =Teflon R = Aramid	B =Carbon Steel S = 316LSS	1= 1/4" NPT	1 = Carbon Steel 2 = 304SS**
	11 = Threaded offline w/flush conn.		3= 1/2" 4= 3/4" 5= 1"					3= 1/2" NPT	
W Welded Inline	35 = Threaded in line	X = Depends on final configuration	1= 1/4" 3= 1/2" 4= 3/4" 5= 1" 7= 1-1/2" 8= 2"	3 =Pipe Size					
W Welded Flanged	25 = Flanged off line	9 = ANSI B16.5	5= 1"	A =150#RF B =300#RF C =600#RF M =1500#RTJ	SS = 316LSS/316LSS EE = Hastelloy C/Hastelloy C JT = Monel/Tantalum ET = Hastelloy C/Tantalum	G =Grafoil K =C-4401 T =Teflon R = Aramid	B =Carbon Steel S =316LSS	1= 1/4" NPT	X = Depends on construction type 3= 1/2" NPT
	26 = Flanged off line w/flush		7= 1-1/2" 8= 2"						
	51 = Flanged in line								
M Mini	10 = Threaded	A = 1000	1= 1/4"	1 = NPT Female (standard) 5 = NPT Male (req. quote)	SS = 316SS/316LSS EE = Hastelloy C/Hastelloy C	0 =N/A	R =316SS	1= 1/4"	0 = N/A
	11 = Threaded w/flush	B = 2000	3= 1/2"					3= 1/2"	
S Sanitary	70 = Tri-Clamp	X = Depends on clamp	7= 1-1/2" 8= 2" 9= 3"	2 =Sanitary Fitting	0S = 316LSS Diaphragm	0 =N/A	S =316LSS	1= 1/4" 3= 1/2"	0 = N/A

* All pressure ratings for diaphragm seals are at 100°F. Higher temperatures will lower the maximum working pressure.

** Bolts - Max. pressure rating is 1,250 PSI when 304 S.S. bolts are used.

Note: Other configurations available (consult factory).

EXAMPLE:

Specs: Welded, Threaded w/1/2" NPT process conn., 316LSS Lower Hse. Mat., 316LSS Diaphragm, C-4401 Gasket, Carbon Steel Upper, and 1/4" NPT Inst. Conn.

Select:

W	10	X	3	1	SS	K	B	1	1
---	----	---	---	---	----	---	---	---	---

Ordering Format: W10X31SSKB11

► DIAPHRAGM SEAL FILLING OPTIONS

(Required when assembling seal with gauge)

MATERIAL	TEMPERATURE RANGE	PART NUMBER
Glycerine (Food Grade)	+30 to +300°F (-1 to 149°C)	Assembly-G
Silicone Oil, 350CS (Food Grade)	-55 to 500°F (-48 to 260°C)	Assembly-S350
* Fluorolube	-40 to 500°F (-40 to 260°C)	Assembly-FS-5
* Halocarbon	-40 to 400°F (-40 to 204°C)	Assembly-H-10

* Fluorolube FS-5 and Halocarbon H-10 - DO NOT use in contact with aluminum or magnesium.

NOTE: OTHER FILLS AVAILABLE



ADDITIONAL PRODUCTS AVAILABLE FROM TEL-TRU

- Pressure Transmitters
- Sanitary Pressure Gauges
- Bimetal Thermometers
- Sanitary Bimetal Thermometers
- Glow Dial Thermometers
- Sanitary and Industrial RTDs
- Digi-Tel Thermometers
- Digi-Tel Sanitary Thermometers
- Digi-Tel Temperature Transmitter
- Electronic Calibration Instruments
- Gas Actuated Thermometers
- Vapor Tension Thermometers
- Non-Contact Thermometers
- Glass Industrial Thermometers
- Thermowells
- Surface Thermometers



Bimetal Thermometers



Thermowells



Gas Actuated Thermometers